

Contents

Chapter 1 Introduction to SY8600 Series Inverter	1
1.1 Product Model Description.....	1
1.2 Product Nameplate Description	1
1.3 Product Series.....	6
1.4 Product Specifications	8
1.5 Product Component Name	11
1.6 Product Outline, Mounting Dimension, and Weight	11
1.7 Operation Panel Outline and Mounting Dimension.....	13
1.8 Pallet Outline and Mounting Dimension	14
1.9 Braking Resistor Lectotype.....	15
Chapter 2 Inverter Installation	16
2.1 Environment for Product Installation	16
2.2 Mounting Direction and Space	16
2.3 Removal and Mounting of Operation Panel and Cover.....	17
Chapter 3 Wiring of Inverter	21
3.1 Connection of the Product and Peripheral Devices	21
3.2 Description of Peripheral Devices for Main Circuit.....	22
3.3 Lectotype of mMain Circuit Peripheral Devices	22
3.4 Product Terminal Configuration.....	24
3.5 Functions of Main Circuit Terminal	25
3.6 Attention for Main Circuit Wiring.....	25
3.7 Terminal Wiring	28
3.8 Functions of Control Circuit Terminals.....	29
3.9 Lectotype of Control Circuit Peripheral Devices	30
3.10 Description of Jumper Function	30
.....	30
Chapter 4 Using Instructions of Operation Panel	31
4.1 Introduction to Operation Panel	31
4.2 Descriptions of Indicators	31
4.3 Description of Keys on Operation Panel.....	32
4.4 Keypad Operating Status.....	33
4.5 Panel Operation Method.....	34
4.6 Parameter Display.....	35
4.7 Motor auto-tuning procedure	36
4.8 Running for the First Time	37
Chapter 5 List of Parameters	38
Function Parameter Table.....	38
Chapter 6 Detail Function Introduction	56



P0 Basic function parameters.....	56
P1 Auxiliary function parameters 1	61
P2 Auxiliary function parameters 2	65
P3 Motor parameters.....	70
P4 Dedicatd function for V/F control.....	71
P5 Vector control funtion	73
P6 I/O I/O output terminal.....	77
P7 Analog input terminal function	90
P8 Analog output terminal	92
P9 Program operating parameters.....	94
PA PID parameter	97
Pb Traverse function	100
PC Communication and Bus control function.....	102
Pd Faults and protection parameters	103
PE Factory reserved	106
PF Factory reserved.....	106
PH Display function.....	106
Chapter 7 Fault diagnosis and troubleshooting	109
7.1 Fault query at fault.....	109
7.2 List of Fault and Alarm Information	109
7.3 Troubleshooting Procedures.....	114
Chapter 8 Routine Repair and Maintenance	115
8.1 Routine Maintenance	115
8.2 Periodic Maintenance.....	116
8.3 Component Replacement.....	116
8.4 Insulation Test	117
Appendix A Communication Protocol	118
Appendix B Control Mode Setting Process.....	133

Chapter 1 Introduction to SY8600 Series Inverter

1.1 Product Model Description

The digits and letters in the inverter model field on the nameplate indicate such information as the product series, power supply class, power class and software/hardware versions.

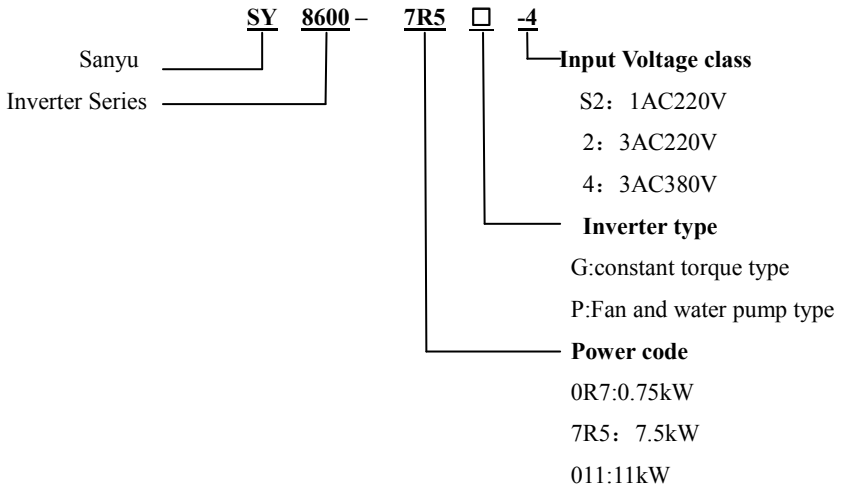

Fig. 1-1 Inverter symbol description

1.2 Product Nameplate Description

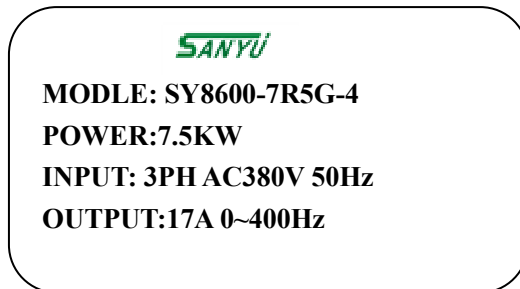

Fig. 1-2 Inverter Nameplate

Safety Precautions

Description of safety marks:



Danger: The misuse may cause fire, severe injury, even death.



Note: The misuse may cause medium or minor injury and equipment damage.

■ Use



Danger

- This series of inverter is used to control the variable speed operation of three-phase motor and cannot be used for single-phase motor or other applications. Otherwise, inverter failure or fire may be caused.
- This series of inverter cannot be simply used in the applications directly related to the human safety, such as the medical equipment.
- This series of inverter is produced under strict quality management system. If the inverter failure may cause severe accident or loss, safety measures, such as redundancy or bypass, shall be taken.

■ Goods Arrival Inspection



Note

- If the inverter is found to be damaged or lack parts, the inverter cannot be installed. Otherwise, accident may be caused.

■ Installation



Note

- When handling and installing the product, please hold the product bottom. Do not hold the enclosure only. Otherwise, your feet may be injured and the inverter may be damaged because of dropping.
- The inverter shall be mounted on the fire retardant surface, such as metal, and kept far away from the inflammables and heat source.
- Keep the drilling scraps from falling into the inside of the inverter during the installation; otherwise, inverter failure may be caused.
- When the inverter is installed inside the cabinet, the electricity control cabinet shall be equipped with fan and ventilation port. And ducts for radiation shall be constructed in the cabinet.

■ Wiring



- The wiring must be conducted by qualified electricians. Otherwise, there exists the risk of electric shock or inverter damage.
- Before wiring, confirm that the power supply is disconnected. Otherwise, there exists the risk of electric shock or fire.
- The grounding terminal PE must be reliably grounded, otherwise, the inverter enclosure may become live.
- Please do not touch the main circuit terminal. The wires of the inverter main circuit terminals must not contact the enclosure. Otherwise, there exists the risk of electric shock.
- The connecting terminals for the braking resistor are \oplus 2/B1 and B2. Please do not connect terminals other than these two. Otherwise, fire may be caused.
- The leakage current of the inverter system is more than 3.5mA, and the specific value of the leakage current is determined by the use conditions. To ensure the safety, the inverter and the motor must be grounded.



- The three-phase power supply cannot connect to output terminals U/T1, V/T2 and W/T3, otherwise, the inverter will be damaged.
- It is forbidden to connect the output terminal of the inverter to the capacitor or LC/RC noise filter with phase lead, otherwise, the internal components of the inverter may be damaged.
- Please confirm that the power supply phases, rated voltage are consistent with that of the nameplate, otherwise, the inverter may be damaged.
- Do not perform dielectric strength test on the inverter, otherwise, the inverter may be damaged.
- The wires of the main circuit terminals and the wires of the control circuit terminals shall be laid separately or in a square-crossing mode, otherwise, the control signal may be interfered.
- The wires of the main circuit terminals shall adopt lugs with insulating sleeves.
- The inverter input and output cables with proper sectional area shall be selected according to the inverter power.
- When the length of the cables between the inverter and the motor is more than 100m, it is suggested to use output reactor to avoid the inverter failure caused by the overcurrent of the distribution capacitor.
- The inverter which equipped with DC reactor must connect with DC reactor between the terminal of \oplus 1、 \oplus 2, otherwise the inverter will not display after power on.

■ Operation



- Power supply can only be connected after the wiring is completed and the cover is installed. It is forbidden to remove the cover in live condition; otherwise, there exists the risk of electric shock.
- When auto failure reset function or restart function is set, isolation measures shall be taken for the mechanical equipment, otherwise, personal injury may be caused.
- When the inverter is powered on, even when it is in the stop state, the terminals of the inverter are still live. Do not touch the inverter terminals; otherwise electric shock may be caused.
- The failure and alarm signal can only be reset after the running command has been cut off. Otherwise, personal injury may be caused.



- Do not start or shut down the inverter by switching on or off the power supply, otherwise, the inverter may be damaged.
- Before operation, please confirm if the motor and equipment are in the allowable use range, otherwise, the equipment may be damaged.
- The heatsink and the braking resistor have high temperature. Please do not touch such device; otherwise, you may be burnt.
- When it is used on lifting equipment, mechanical contracting brake shall also be equipped.
- Please do not change the inverter parameter randomly. Most of the factory set parameters of the inverter can meet the operating requirement, and the user only needs to set some necessary parameters. Any random change of the parameter may cause the damage of the mechanical equipment.
- In the applications with industrial frequency and variable frequency switching, the two contactors for controlling the industrial frequency and variable frequency switching shall be interlocked.

■ Maintenance, Inspection



- In the power-on state, please do not touch the inverter terminals; otherwise, there exists the risk of electric shock.
- If cover is to be removed, the power supply must be disconnected first.
- Wait for at least 10 minutes after power off or confirm that the CHARGE LED is off before maintenance and inspection to prevent the harm caused by the residual voltage of the main circuit electrolytic capacitor to persons.
- The components shall be maintained, inspected or replaced by qualified electricians.



Note

- The circuit boards have large scale CMOS IC. Please do not touch the board to avoid the circuit board damage caused by electro static.

■ **Others**



Danger

- It is forbidden to modify the inverter unauthorizedly; otherwise, personal injury may be caused.

1.3 Product Series

■ **SY8600-□□□G-4** Three-phase 400V Constant torque/heavy-duty application

Power (kW)	0.75	1.5	2.2	4.0	5.5	7.5	11	15	18.5	22	30	37	45	55	75	
Motor power (kW)	0.75	1.5	2.2	4.0	5.5	7.5	11	15	18.5	22	30	37	45	55	75	
Output	Voltage (V)	Three-phase 0 to rated input voltage														
	Rated current (A)	2.5	3.8	5.5	9	13	17	24	30	39	45	60	75	91	112	150
	Overload capacity	150% 1 minute, 180% 2 seconds, 200% 0.5 second, interval: 10 minutes (inverse time lag feature)														
Input	Rated voltage/frequency	Three-phase 380V/480V; 50Hz/60Hz														
	Allowable voltage range	323V ~ 528V; Voltage unbalancedness ≤3%; allowable frequency fluctuation: ±5%														
	Rated current (A)	3.5	6.2	9.2	14.9	21.5	27.9	39	50.3	60	69.3	86	104	124	150	201
Braking unit	Built-in as standard								Built-in as option							
Protection class	IP20															
Cooling mode	Self-cooling	Forced air convection cooling														
Power (kW)	90	110	132	160	185	200	220	250	280	315	355	400	450	500		
Motor power (kW)	90	110	132	160	185	200	220	250	280	315	355	400	450	500		
Output	Voltage (V)	Three-phase 0 to rated input voltage														
	Rated current (A)	176	210	253	304	350	380	426	470	520	600	650	690	775	860	
	Overload capacity	150% 1 minute, 180% 10 seconds, 200% 0.5 second, interval: 10 minutes (inverse time lag feature)														
Input	Rated voltage/frequency	Three-phase 380V/480V; 50Hz/60Hz														
	Allowable voltage range	323V ~ 528V; Voltage unbalancedness ≤3%; allowable frequency fluctuation: ±5%														
	Rated current (A)	160*	196*	232*	282*	326*	352*	385*	437*	491*	580*	624*	670*	755*	840*	
Braking unit	External braking unit needed															
Protection class	IP20															
Cooling mode	Forced air convection cooling															

*SY8600-090G-4 and above products are equipped with external DC reactor as standard.

■ **SY8600-□□□P-4** Three-phase 400V Variable torque/light-duty application

Power (kW)	1.5	2.2	4.0	5.5	7.5	11	15	18.5	22	30	37	45	55	75	90	
Motor power (kW)	1.5	2.2	4.0	5.5	7.5	11	15	18.5	22	30	37	45	55	75	90	
Output	Voltage (V)	Three-phase 0 to rated input voltage														
	Rated current (A)	3.3	5.0	7.5	11	17	22	30	37	44	56	72	91	110	142	176
	Overload capacity	120% 1 minute, 145% 2 second, interval: 10 minutes (inverse time lag feature)														
Input	Rated voltage/frequency	Three-phase 380V/480V; 50Hz/60Hz														
	Allowable voltage fluctuation range	323V ~ 528V; Voltage unbalancedness: ≤3%; allowable frequency fluctuation: ±5%														
	Rated current (A)	5.6	8.1	13.5	19.5	26	39	50.3	60	69.3	86	104	124	150	190	235
Braking unit	Built-in as standard							Built-in as option								
Protection class	IP20															
Cooling mode	Self-cooling			Forced air convection cooling												
Power (kW)	110	132	160	185	200	220	250	280	315	355	400	450	500	560		
Motor power (kW)	110	132	160	185	200	220	250	280	315	355	400	450	500	560		
Output	Voltage (V)	Three-phase 0 to rated input voltage														
	Rated current (A)	210	253	304	350	380	426	470	520	600	650	690	775	860	950	
	Overload capacity	115% 1 minute, 160% 0.5 second, interval: 10 minutes (inverse time lag feature)														
Input	Rated voltage/frequency	Three-phase 380V/480V; 50Hz/60Hz														
	Allowable voltage range	323V ~ 528V; Voltage unbalancedness ≤3%; allowable frequency fluctuation: ±5%														
	Rated current (A)	196*	232*	282*	326*	352*	385*	437*	491*	580*	624*	670*	755*	840*	920*	
Braking unit	External braking unit needed															
Protection class	IP20															
Cooling mode	Forced air convection cooling															

*SY8600-110P-4 and above products are equipped with external DC reactor as standard.

■ **SY8600-□□□G-2** Three-phase 200V Constant torque/heavy-duty application

Power (kW)	0.4			0.75			1.5			2.2			
Motor power (kW)	0.4			0.75			1.5			2.2			
Output	Voltage (V)	Three-phase 0 to rated input voltage											
	Rated current (A)	3			5			7.5			10		
	Overload capacity	150% 1 minute, 180% 10 seconds, 200% 0.5 second, interval: 10 minutes (inverse time lag feature)											
Input	Rated voltage/frequency	Three-phase or single-phase 200V~240V; 50Hz/60Hz											
	Allowable voltage range	180V ~ 260V; Voltage unbalancedness ≤3%; allowable frequency fluctuation: ±5%											
	Rated current (A)	3.8			5.5			8.3			12		
Braking unit	Built-in as standard												
Protection class	IP20												
Cooling mode	Self-cooling					Forced air convection cooling							

1.4 Product Specifications

Item		Specifications
OUTPUT	Rated Output Voltage	Three phase 380V (Max output voltage is equal to input voltage)
	Max continuous current	100% rated output current
	Overload ability	150% rated current for 1minutes, 180% rated current for 2 seconds.
	Output frequency	0Hz~400Hz
Input	Rated input voltage	Three phase: 380V±20%, 50~60Hz±5%
Control performance	AVR Function,	When AVR function is enable, output voltage is stable under input voltage fluctuation
	Modulation modes	Optimized space voltage vector PWM modulation
	Control mode	Sensorless Vector control; V/F control.
	Running command input modes	Panel control, external terminal control, control by serial port of host computer
	Speed setting mode	Ten kinds of main frequencysetting modes, seven kinds of Auxiliary frequencysetting modes. Several combination kinds of main frequencysetting modes and Auxiliary frequencysetting modes.
	Speed setup resolution	Digital setting: 0.01Hz. Analog setting: highest frequency×0.1%
	Voltage/Frequency characteristic	Rated voltage: 50-100%,adjustable, Base frequency 50Hz, adjustable, five type V/F curves
	Speed control accuracy	Sensorless vector control: ±0.05% rated speed(25℃±10℃)
	Speed control range	vector control: 1:100
	Starting torque	vector control: 150% rated torque at 0.5Hz.
	Acc/dec characteristic	0.1seconde~3600 seconds
Braking torque	22 kW below: >20% rated torque, 30 kW above: >15% rated torque	
Control I/O	Reference voltage output	1 channel, +10V, 50mA
	Control voltage output	24V, 100mA

signal	Analog input	1 channel, 0~10V/0~20mA DC, 10 bit; 1 channel, 0~10 V DC, 10 bit
	Analog output	1 channel, 0~10V, output programmable, various output selectable 1 channel, 0~10V/0-2.0mA, output programmable, various output selectable
	Programmable terminal input	7 programmable channels, 27 kinds of functions can be selected, such as Run forward/reverse, Jog forward/reverse, multi-step speed selection, multi-step Acc/Dec time, free run to stop, voltage/current switch, etc.
	Open collector output	1 channel, 20 optional running states, the maximum output current is 50mA
	Programmable relay output	1 channel, 20 optional running states, contact capacity: 250V AC /3A or 30V DC /1A
	Serial port	RS-485 port
Standard function		urrent limit, torque boost, speed trace, DC braking, restart after power failure, slip compensation, auto fault reset, high/low limit frequency, starting frequency, jump frequency, frequency gain, Carrier frequency adjustment, Acc/Dec mode selection, voltage meter output, current meter output, multi-frequency operation, programming operation, traverse operation, PI close loop operation, proportional control, remote control, FWD/REV dead time, etc.
Protection function		Over voltage, low voltage, over current, current limit, overload, over heat, electronic thermal overload relay, over voltage stall, data protection, etc.
Display	4-digit display (LED)	15 kinds of parameters, such as frequency setting, output frequency, output voltage, output current, motor speed, output torque, digital value terminals, program menu parameters and 33 kinds of Fault codes
	Indicator (LED)	Parameter unit, RUN/STOP state, etc.
Operating environment	Environment	Inside, low than 1000m, free from dust, corrosive gas and direct sunlight
	Ambient temperature	-10℃~+40℃ (bare machine: -10℃~+50℃), 20%~90%RH, no condensing
	Vibration	Lower than 0.5g
	Storage temperature	-25℃~+65℃
	Installation	Wall mounted or surface mounted inside a cabinet
Protection class		IP20

Cooling	0.75 kW and below: enclosed self-cooling, Others: forced cooling.
---------	--

1.5 Product Component Name

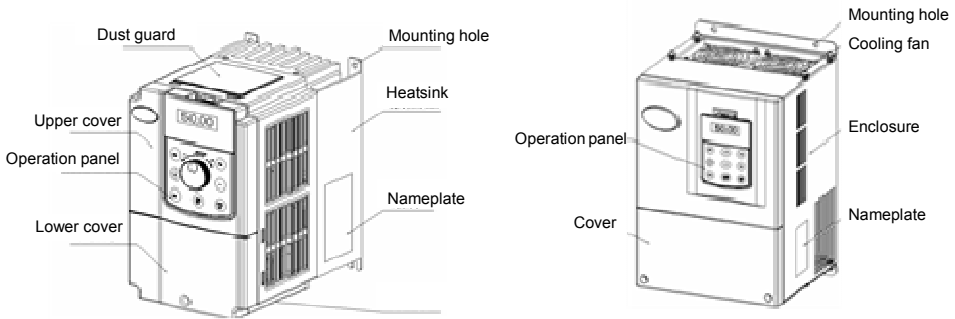

SY8600-0R4G-2~SY8600-2R2G-2

SY8600-7R5G-4 and below power class

SY8600-011G-4 and above power class

Fig.1-3 Product component name

1.6 Product Outline, Mounting Dimension, and Weight

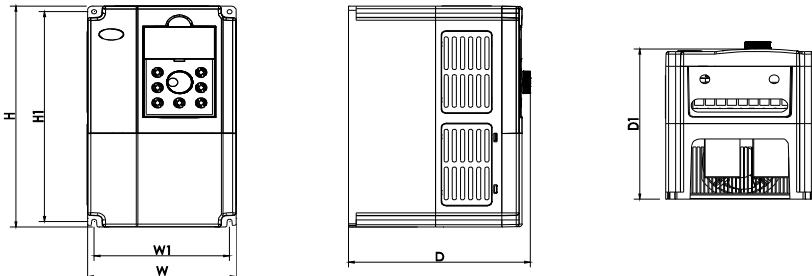

SY8600-0R4G-2~SY8600-2R2G-2, SY8600-0R7G-4~SY8600-7R5G-4 and blow power class

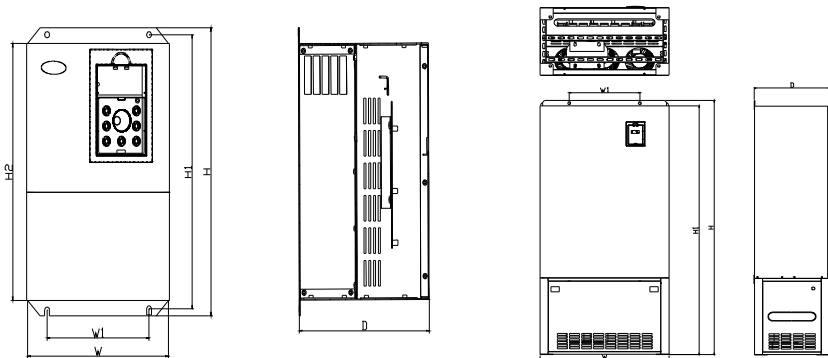

SY8600-011G-4~ SY8600-220G-4 power class

SY8600-185G-4~SY8600-400G-4

Fig.1-4 Product outline and mounting dimension

Product outline, mounting dimension, and weight

Voltage class	Inverter model	Outline and mounting dimension (mm)							Mounting hole diameter	Approximate weight (kg)
		W	H	D	W1	H1	D1	H2		
220V	SY8600-0R4G-2/0R7G-2	118.5	185	159	106.5	174.5	150		5.5	2.0
	SY8600-1R5G-2/2R2G-2									
	SY8600-3R7G-2	150	258	183.8	136.8	245	175.3		5.5	4.5
400V	SY8600-0R7G-4/1R5P-4	118.5	185	159	106.5	174.5	150		5.5	2.0
	SY8600-1R5G-4/2R2P-4									
	SY8600-2R2G-4/4R0P-4									
	SY8600-4R0G-4/5R5P-4	118.5	195	169	106.5	184.5	160		5.5	3.0
	SY8600-5R5G-4/7R5P-4	150	258	183.8	136.8	245	175.3		5.5	4.5
	SY8600-7R5G-4									
	SY8600-011P-4	210	337	191	150	322.5			7	8.5
	SY8600-011G-4/015P-4									
	SY8600-015G-4/018P-4									
	SY8600-018G-4/022P-4	285	501	230.2	200	482			7	17
	SY8600-022G-4/030P-4									
	SY8600-030G-4/037P-4									
	SY8600-037G-4/045P-4	352	585	274.2	220	559			10	25
	SY8600-045G-4/055P-4									
	SY8600-055G-4									
	SY8600-075P-4	404	680	302.7	300	658			10	35
	SY8600-075G-4/093P-4									
	SY8600-093G-4	485	760	316	325	739			12	55
	SY8600-110P-4									
	SY8600-110G-4									
SY8600-132P-4										
SY8600-132G-4	533	830	371.7	325	809			12	85	
SY8600-160P-4										
SY8600-160G-4										
SY8600-185P-4										
Wall Mounted	638	1010	374	350	985			14	125	
SY8600-185G-4										
SY8600-200P-4										
SY8600-200G-4										
SY8600-220P-4										

SY8600-220G-4 SY8600-250P-4								
Cabinet								
SY8600-185G-4 SY8600-200P-4	638	140 2	374	350	1372		14	140
SY8600-200G-4 SY8600-220P-4								
SY8600-220G-4 SY8600-250P-4								
Wall Mounted								
SY8600-250G-4 SY8600-280P-4	700	124 0	460	520	1207.5		14	150
SY8600-280G-4 SY8600-315P-4								
SY8600-315G-4								
Cabinet								
SY8600-250G-4 SY8600-280P-4	700	162 7	460	520	1592		14	180
SY8600-280G-4 SY8600-3150P-4								
SY8600-315G-4								
SY8600-355P-4								
SY8600-355G-4 SY8600-400P-4	800	177 2	460	520	1737		14	215
SY8600-400G-4 SY8600-450P-4								

1.7 Operation Panel Outline and Mounting Dimension

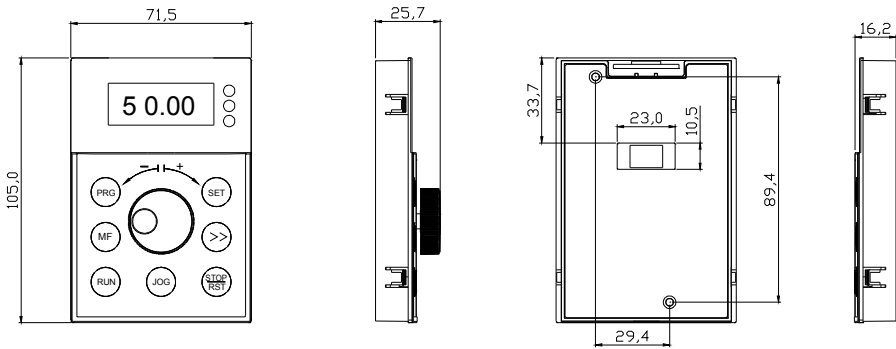

Shuttle type operation panel (SY8600-DP01)

Rear view of operation panel

Fig. 1-5 Operation panel outline and mounting dimension

1.8 Pallet Outline and Mounting Dimension

SY8600-DP03 is the mounting pallet when the operation panel is to install on the electric control cabinet.
The outline and dimension are as follows:

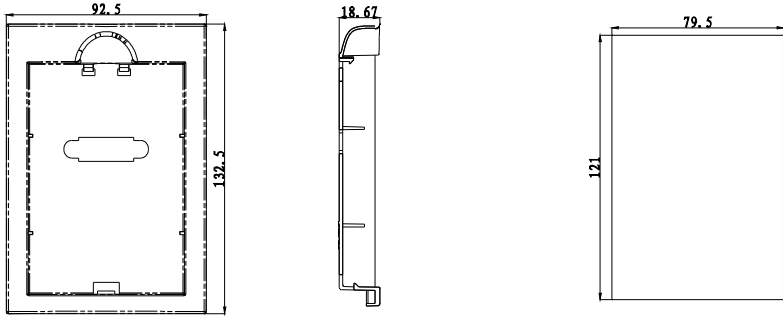

Pallet (SY8600-DP03)

Open pore dimension of pallet

Fig. 1-6 Pallet outline and mounting dimension

1.9 Braking Resistor Lectotype

Inverter model	Braking unit	Braking resistor unit			Braking torque%
		Power	Resistor	Qty.	
SY8600-0R4G-2	Built-in as standard	70W	200Ω	1	220
SY8600-0R7G-2		70W	200Ω	1	125
SY8600-1R5G-2		260W	100Ω	1	125
SY8600-2R2G-2		260W	70Ω	1	120
SY8600-0R7G-4/1R5P-4		70W	750Ω	1	130
SY8600-1R5G-4/2R2P-4		260W	400Ω	1	125
SY8600-2R2G-4/4R0P-4		260W	250Ω	1	135
SY8600-4R0G-4/5R5P-4		390W	150Ω	1	135
SY8600-5R5G-4/7R5P-4		520W	100Ω	1	135
SY8600-7R5G-4/011P-4		780W	75Ω	1	130
SY8600-011G-4/015P-4		1040W	50Ω	1	135
SY8600-015G-4/018P-4		1560W	40Ω	1	125
SY8600-018G-4/022P-4		Built-in as option	4800W	32Ω	1
SY8600-022G-4/030P-4	4800W		27.2Ω	1	125
SY8600-030G-4/037P-4	6000W		20Ω	1	125
SY8600-037G-4/045P-4	9600W		16Ω	1	125
SY8600-045G-4/055P-4	9600W		13.6Ω	1	125
SY8600-055G-4/075P-4	6000W		20Ω	2	135
SY8600-075G-4/090P-4	9600W		13.6Ω	2	145

Note: The connection mode for multiple braking resistors is parallel connection. For example, the inverter of SY8600-055G-4/075P-4, the braking resistor lectotype: it is suggest to select two 6000W, 20Ω braking resistor parallel connection, amount to braking resistor is 12000W, 10Ω.

Chapter 2 Inverter Installation

2.1 Environment for Product Installation

- Avoid installing the product in the sites with oil mist, metal powder and dust.
- Avoid installing the product in the sites with hazardous gas and liquid, and corrosive, combustible and explosive gas.
- Avoid installing the products in salty sites.
- Do not install the product in the sites with direct sunlight.
- Do not mount the product on the combustible materials, such as wood.
- Keep the drilling scraps from falling into the inside of inverter during the installation.
- Mount the product vertically in the electric control cabinet, mount the cooling fan or air conditioner to prevent the ambient temperature from rising to above 45 °C.
- For the sites with adverse environment, it is recommended to mount the inverter heatsink outside the cabinet.

2.2 Mounting Direction and Space

In order not to reduce the inverter cooling effect, the inverter must be mounted vertically, and certain space must be maintained, as shown in Fig. 2-1 and Fig.2-2.

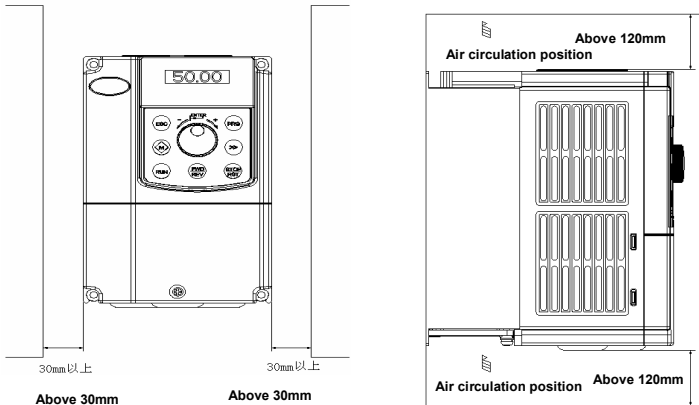

Fig.2-1 Fig.2-1 Mounting direction and space for SY8600-0R4G-2~SY8600-2R2G-2 and SY8600-0R7G-4/1R5P-4 and below power class

Note:

When the SY8600 inverters are mounted side by side in the cabinet, please remove the upper dust guard and the lower leading board.

2.3 Removal and Mounting of Operation Panel and Cover

2.3.1 Removal and Mounting of Operation Panel

◆ Removal of operation panel

As shown in Fig. 2-3, the grab on the operation panel forcefully in direction 1, and then lift the panel body in direction 2.

◆ Mounting of operation panel

As shown in Fig.2-4, align with the lower clamping position of the operation panel in direction 1, and then press down the operation panel in direction 2, until the “crack” sound is heard.

Do not mount the operation panel in any other direction; otherwise, the operation panel will have poor contact.

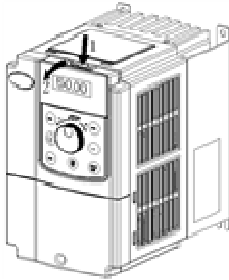

Fig. 2-3 Removal of operation panel

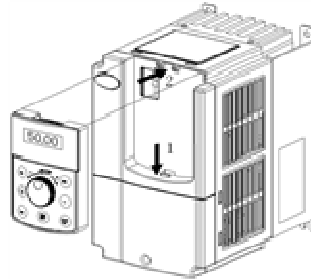

Fig.2-4 Mounting of operation panel

2.3.2 Removal and Mounting of Covers of Inverter with Plastic Enclosure

◆ Removal of operation panel

Please refer to 2.3.1 removal and mounting of operation panel.

◆ Removal of lower cover

After removing the mounting screws of the cover, press the left and right sides of the cover forcefully in direction 1 and at the same time lift the cover in direction 2, as shown in Fig. 2-5.

◆ Removal of upper cover

As shown in Fig.2-6, press the left and right sides of the cover forcefully in direction 1, and at the same time lift the cover in direction 2.

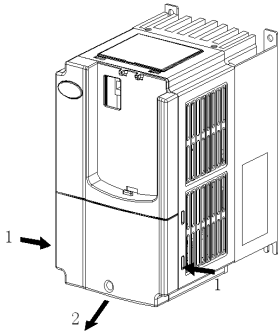

Fig.2-5 Removal of lower cover

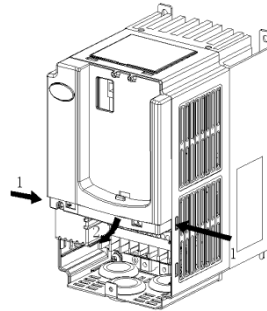

Fig.2-6 Removal of upper cover

◆ Mounting of upper cover

After the wiring of main circuit terminals and control circuit terminals, insert the upper claw grab of the upper cover into the groove of the inverter body, as shown in position 1 in Fig.2-7, and then press the lower part of the upper cover in direction 2 as shown in Fig.2-7, until the “crack” sound is heard.

◆ Mounting of lower cover

Insert the upper claw grab on the lower cover into the groove of the upper cover, as shown in position 1 of Fig.2-8, and then press the lower part of the lower cover in direction 2 of Fig.2-8, until the “crack” sound is heard. Now, tighten the cover screws.

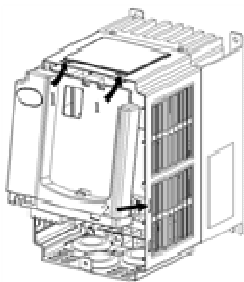

Fig.2-7 Mounting of upper cover

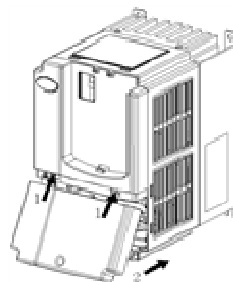

Fig.2-8 Mounting of lower cover'

◆ Mounting of operation panel

Please refer to 2.3.1 Removal and mounting of operation panel.

2.3.3 Removal and Mounting of Covers of SY8600-011G-4/015P-4 ~ SY8600-075G-4/090P-4 and Above Power Class Inverter with Sheet-metal Enclosure

◆ Removal of operation panel

Please refer to 2.3.1 Removal and mounting of operation panel.

◆ Removal of cover

Remove the mounting screws on the lower part of the cover, lift the cover in direction 1 as shown in Fig.2-9, and then take out the cover in direction 2.

◆ Mounting of cover

After the wiring of the main circuit terminals and control circuit terminals, cramp the cover in direction 1 as shown in Fig.2-10, press down the cover in direction 2 and then tighten the cover screws.

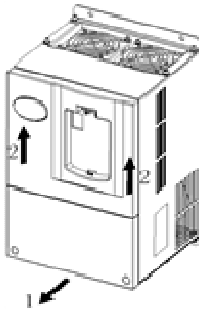

Fig.2-9 Removal of cover

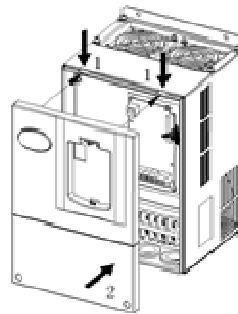

Fig.2-10 Mounting of cover

◆ Mounting of operation panel

Please refer to 2.3.1 Removal and mounting of operation panel.

Note:

Do not directly mount the cover with operation panel on the inverter, otherwise, the operation panel will have poor contact.

2.3.4 Open and Close of Doors of SY8600-090G-4 and Above Power Class Inverter with Sheet-metal Enclosure

◆ Opening of the door

Press the latch following direction 1 in Fig.2-11 and open the door following direction 2.

◆ Removal of operation panel

The operation panel is connected to the control board through the standard network cable and will not interfere with the open/close of the door. To remove the operation panel, refer to section 2.3.1 Removal and Mounting of Operation Panel

◆ Mounting of cover

After the wiring operation of main circuit terminals and control circuit terminals is completed, close the door following direction 1 in Fig.2-12, and then press down the latch following direction 2 to lock the door.

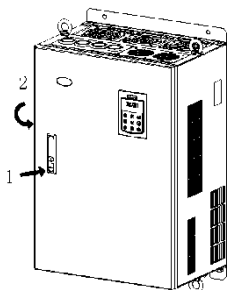

Fig. 2-11 opening the door

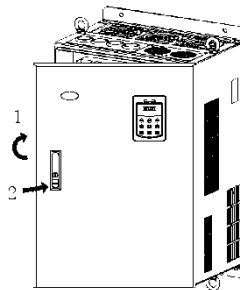

Fig. 2-12 closing the door

Chapter 3 Wiring of Inverter

3.1 Connection of the Product and Peripheral Devices

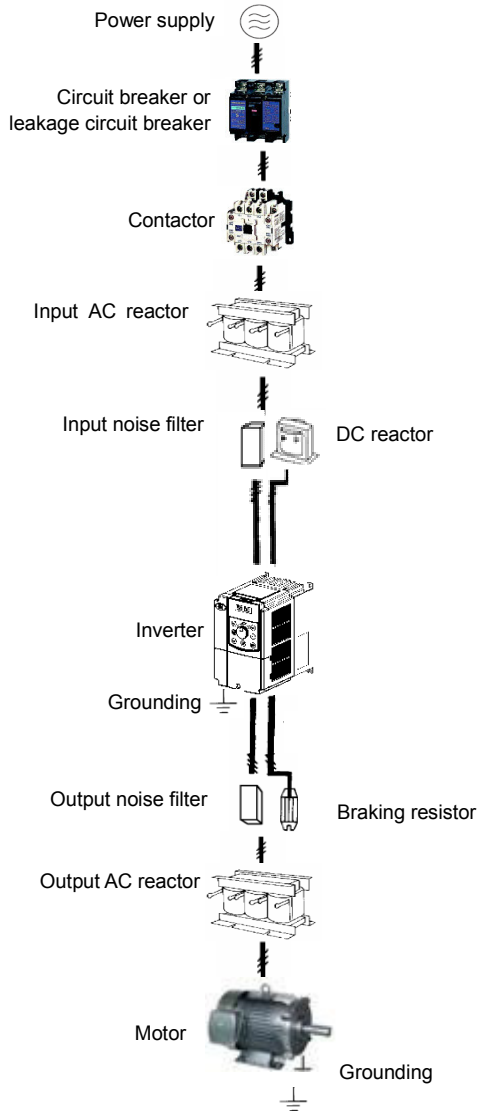

Fig.3-1 Connection diagram of the product and peripheral devices

3.2 Description of Peripheral Devices for Main Circuit

Circuit breaker	The capacity of the circuit breaker shall be 1.5 ~ 2 time of the rated current of the inverter. The time features of the circuit breaker shall fully consider the time features of the inverter overload protection.
Leakage circuit breaker	Because the inverter output is the high-frequency pulse, there will be high-frequency leakage current. Special leakage circuit breaker shall be used when installing leakage circuit breaker at the input end of the inverter. It is suggested that B type leakage circuit breaker be used, and the leakage current value shall be set as 300mA.
Contactors	Frequent open and close of contactor will cause inverter failure, so the highest frequency for the open and close of contactor shall not exceed 10 times/min. When braking resistor is used, to void the overtemperature damage of the braking resistor, thermal protection relay with braking resistor overtemperature detection shall be installed to disconnect the contactor at the contact control power side of the thermal protection relay.
Input AC reactor or DC reactor	<ol style="list-style-type: none"> The inverter power supply capacity is more than 600kVA or 10 times of the inverter capacity. If there is switch type reactive-load compensation capacitor or load with silicon control at the same power node, there will be high peak current flowing into input power circuit, causing the damage of the rectifier components. When the voltage unbalancedness of the three-phase power supply of the inverter exceeds 3%, the rectifier component will be damaged. It is required that the input power factor of the inverter shall be higher than 90%. When the above situations occur, install the AC reactor at the input end of the inverter or DC reactor to the DC reactor terminal.
Input noise filter	The noise input from the power end to the inverter and output from the inverter to the power end can be reduced.
Thermal protection relay	Although the inverter has motor overload protection function, when one inverter drives two or more motors or multi-pole motors, to prevent the motor overtemperature failure, thermal protection relay shall be installed between the inverter and each motor, and the motor overload protection parameter P9.16 shall be set as "2" (motor protection disabled).
Output noise filter	When the output end of the inverter is connected with noise filter, the conduction and radiation interference can be reduced.
Output AC reactor	When the cable connecting the inverter and the motor is longer than 100m, it is suggested to install AC output reactor to suppress the high-frequency oscillation to avoid the damage to motor insulation, large leakage current and frequent inverter protective action.

3.3 Lectotype of mMain Circuit Peripheral Devices

Inverter model	Circuit Breaker (A)	Contact (A)	R/L1, S/L2, T/L3, ⊕1, ⊕2/B1, B2, ⊖, U/T1, V/T2, W/T3			Grounding terminal PE ⊕		
			Terminal screw	Tightening torque (N·m)	Wire specification (mm ²)	Terminal screw	Tightening torque (N·m)	Wire specification (mm ²)
SY8600-0R4G-2	16	10	M4	1.2~1.5	2.5	M4	1.2~1.5	2.5
SY8600-0R7G-2	25	16	M4	1.2~1.5	2.5	M4	1.2~1.5	2.5
SY8600-1R5G-2	32	25	M4	1.2~1.5	4	M4	1.2~1.5	2.5
SY8600-2R2G-2	40	32	M4	1.2~1.5	6	M4	1.2~1.5	4
SY8600-0R7G-4/1R5P-4	10	10	M4	1.2~1.5	2.5	M4	1.2~1.5	2.5
SY8600-1R5G-4/2R2P-4	16	10	M4	1.2~1.5	2.5	M4	1.2~1.5	2.5
SY8600-2R2G-4/4R0P-4	16	10	M4	1.2~1.5	2.5	M4	1.2~1.5	2.5
SY8600-4R0G-4/5R5P-4	25	16	M4	1.2~1.5	4	M4	1.2~1.5	4
SY8600-5R5G-4/7R5P-4	32	25	M4	1.2~1.5	6	M4	1.2~1.5	6
SY8600-7R5G-4/011P-4	40	32	M4	1.2~1.5	6	M4	1.2~1.5	6



Inverter model	Circuit Breaker (A)	Contact (A)	R/L1, S/L2, T/L3, ⊕1, ⊕2/B1, B2, ⊖, U/T1, V/T2, W/T3			Grounding terminal PE ⊕		
			Terminal screw	Tightening torque (N·m)	Wire specification (mm ²)	Terminal screw	Tightening torque (N·m)	Wire specification (mm ²)
SY8600-011G-4/015P-4	63	40	M5	2.5~3.0	6	M5	2.5~3.0	6
SY8600-015G-4/018P-4	63	63	M5	2.5~3.0	6	M5	2.5~3.0	6
SY8600-018G-4/022P-4	100	63	M6	4.0~5.0	10	M6	4.0~5.0	10
SY8600-022G-4/030P-4	100	100	M6	4.0~5.0	16	M6	4.0~5.0	16
SY8600-030G-4/037P-4	125	100	M6	4.0~5.0	25	M6	4.0~5.0	16
SY8600-037G-4/045P-4	160	100	M8	9.0~10.0	25	M8	9.0~10.0	16
SY8600-045G-4/055P-4	200	125	M8	9.0~10.0	35	M8	9.0~10.0	16
SY8600-055G-4/075P-4	315	250	M10	17.6~22.5	50	M10	14.0~15.0	25
SY8600-075G-4/090P-4	350	330	M10	17.6~22.5	60	M10	14.0~15.0	35
SY8600-093G-4 SY8600-110P-4	315	250	M10	17.6~22.5	70	M10	14.0~15.0	35
SY8600-110G-4 SY8600-132P-4	350	330	M10	17.6~22.5	100	M10	14.0~15.0	50
SY8600-132G-4 SY8600-160P-4	400	330	M12	31.4~39.2	150	M12	17.6~22.5	75
SY8600-160G-4 SY8600-185P-4	500	400	M12	31.4~39.2	185	M12	17.6~22.5	50×2
SY8600-185G-4 SY8600-200P-4	630	500	M12	48.6~59.4	240	M12	31.4~39.2	60×2
SY8600-200G-4 SY8600-220P-4	630	500	M12	48.6~59.4	240	M12	31.4~39.2	60×2
SY8600-220G-4 SY8600-250P-4	800	630	M12	48.6~59.4	150×2	M12	31.4~39.2	75×2
SY8600-250G-4 SY8600-280P-4	1000	630	M12	48.6~59.4	185×2	M12	31.4~39.2	100×2
SY8600-280G-4 SY8600-315P-4	1000	630	M12	48.6~59.4	185×2	M12	31.4~39.2	100×2
SY8600-315G-4 SY8600-355P-4	1000	800	M14	48.6~59.4	250×2	M14	31.4~39.2	125×2
SY8600-355G-4 SY8600-400P-4	1200	800	M14	48.6~59.4	325×2	M14	31.4~39.2	150×2
SY8600-400G-4 SY8600-450P-4	1500	1000	M14	48.6~59.4	325×2	M14	31.4~39.2	150×2
SY8600-450G-4 SY8600-500P-4	2000	1500	M14	48.6~59.4	350×2	M14	31.4~39.2	175×2
SY8600-500G-4 SY8600-560P-4	2000	1500	M14	48.6~59.4	350×2	M14	31.4~39.2	175×2

3.4 Product Terminal Configuration

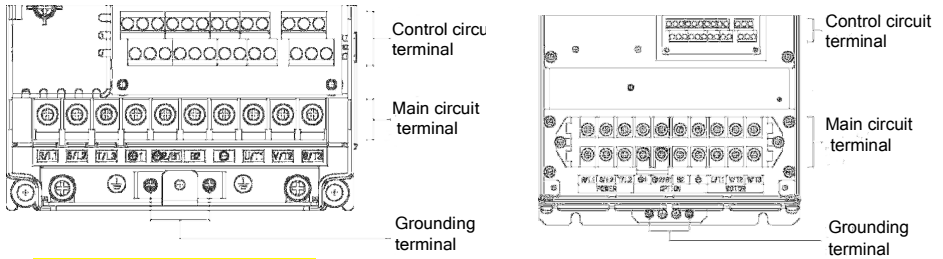

SY8600-0R4-2G~SY8600-2R2G-2

SY8600-7R5G-4/011P-4 and below power class

SY8600-7R5G-4/011P-4 and above power class

Fig.3-2 Product terminal configuration

3.5 Functions of Main Circuit Terminal

3.5.1 SY8600-0R4G-2 ~ SY8600-2R2G-2 和 SY8600-0R7G-4/1R5P-4 ~ SY8600-015G-4/018P-4

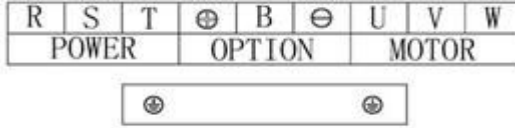

Terminal symbol	Terminal name and function description
R、S、T	Three-phase AC input terminal
⊕、B	Connecting terminal of braking resistor
⊕、⊖	DC power input terminal; DC input terminal of external braking unit
U、V、W	Three-phase AC output terminal
⊕	Grounding terminal PE

3.5.2 SY8600-018G-4/022P-4~SY8600-630G-4

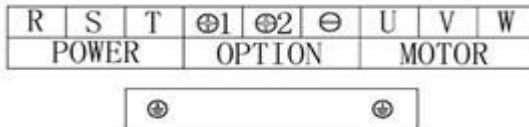

Terminal symbol	Terminal name and function description
R、S、T	Three-phase AC input terminal
⊕1、⊕2	DC reactor connecting terminal, short circuited with copper bus upon
⊕2、⊖	DC power input terminal; DC input terminal of external braking unit
U、V、W	Three-phase AC output terminal
⊕	Grounding terminal PE

3.6 Attention for Main Circuit Wiring

3.6.1 Power Supply Wiring

- ◆ It is forbidden to connect the power cable to the inverter output terminal, otherwise, the internal components of the inverter will be damaged.
- ◆ To facilitate the input side overcurrent protection and power failure maintenance, the inverter shall connect to the power supply through the circuit breaker or leakage circuit breaker and contactor.
- ◆ Please confirm that the power supply phases, rated voltage are consistent with that of the nameplate, otherwise, the inverter may be damaged.

3.6.2 Motor Wiring

It is forbidden to short circuit or ground the inverter output terminal, otherwise the internal

components of the inverter will be damaged.

- ◆ Avoid short circuit the output cable and the inverter enclosure, otherwise there exists the danger of electric shock.
- ◆ It is forbidden to connect the output terminal of the inverter to the capacitor or LC/RC noise filter with phase lead, otherwise, the internal components of the inverter may be damaged.
- ◆ When contactor is installed between the inverter and the motor, it is forbidden to switch on/off the contactor during the running of the inverter, otherwise, there will be large current flowing into the inverter, triggering the inverter protection action.
- ◆ Length of cable between the inverter and motor

If the cable between the inverter and the motor is too long, the higher harmonic leakage current of the output end will cause adverse impact on the inverter and the peripheral devices. It is suggested that when the motor cable is longer than 100m, output AC reactor be installed. Refer to the following table for the carrier frequency setting.

Length of cable between the inverter and motor	Less than 50m	Less than 100 m	More than 100m
Carrier frequency (PA.00)	Less than 15kHz	Less than 10kHz	Less than 5kHz

3.6.3 Grounding Wiring

- ◆ The inverter will produce leakage current. The higher the carrier frequency is, the larger the leakage current will be. The leakage current of the inverter system is more than 3.5mA, and the specific value of the leakage current is determined by the use conditions. To ensure the safety, the inverter and the motor must be grounded.
- ◆ The grounding resistance shall be less than 10ohm. For the grounding wire diameter requirement, refer to 3.3 lectotype of main circuit peripheral devices.
- ◆ Do not share grounding wire with the welding machine and other power equipment.
- ◆ In the applications with more than 2 inverters, keep the grounding wire from forming a loop.



Fig. 3–3 Grounding wiring

3.6.4 Countermeasures for Conduction and Radiation Interference

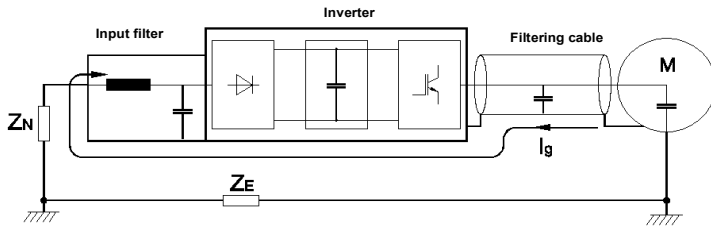

Fig.3-4 Noise current illustration

- ◆ When the input noise filter is installed, the wire connecting the filter to the inverter input power end shall be as short as possible.
- ◆ The filter enclosure and mounting cabinet shall be reliably connected in large area to reduce the back flow impedance of the noise current I_g .
- ◆ The wire connecting the inverter and the motor shall be as short as possible. The motor cable adopts 4-core cable, with the grounding end grounded at the inverter side, the other end connected to the motor enclosure. The motor cable shall be sleeved into the metal tube.
- ◆ The input power wire and output motor wire shall be kept away from each other as long as possible.
- ◆ The equipment and signal cables vulnerable to influence shall be kept far away from the inverter.
- ◆ Key signal cables shall adopt shielding cable. It is suggested that the shielding layer shall be grounded with 360-degree grounding method and sleeved into the metal tube. The signal cable shall be kept far away from the inverter input wire and output motor wire. If the signal cable must cross the input wire and output motor wire, they shall be kept orthogonal.
- ◆ When analog voltage and current signals are adopted for remote frequency setting, twinning shielding cable shall be used. The shielding layer shall be connected to the grounding terminal PE of the inverter, and the signal cable shall be no longer than 50m.
- ◆ The wires of the control circuit terminals RA/RB/RC and other control circuit terminals shall be separately routed.
- ◆ It is forbidden to short circuit the shielding layer and other signal cables or equipment.
- ◆ When the inverter is connected to the inductive load equipment (e.g. electromagnetic contactor, relay and solenoid valve), surge suppressor must be installed on the load equipment coil, as shown in Fig.3-5.

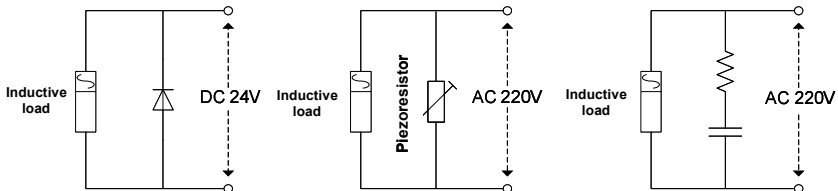

Fig.3-5 Application of inductive load surge suppressor

3.7 Terminal Wiring

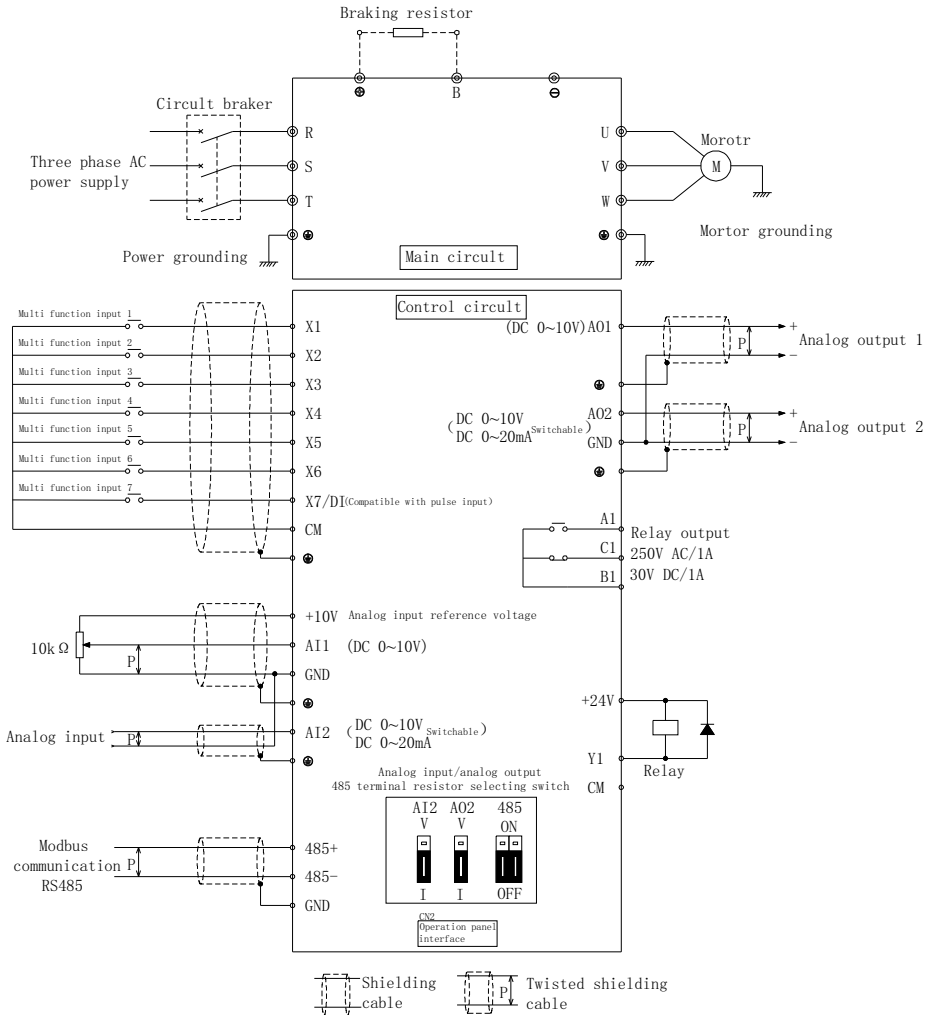

Fig.3-6 Terminal wiring diagram (take SY8600-015G-4/018P-4 as an example)

3.8 Functions of Control Circuit Terminals

Type	Terminal symbol	Terminal function description	Technical specification
Terminal 485	485+	Positive end of 485 differential signal	Rate: 4800/9600/19200/38400/57600bps Up to 32 sets of equipment can be paralleled. Relay shall be used if the number exceeds 32. Maximum distance: 500m (adopt standard twisted shielding cable)
	485-	Negative end of 485 differential signal	
	GND	Shielding grounding of 485 communication	Internal isolated with COM
Operation panel 485	CN2	485 port of operation panel	When used for communication connection with host
			The maximum distance is 15m for the communication connection of operation panel
Digital input	+24V	+24V	24V±10%, internal isolated with GND, Maximum load: 200mA, with overload and short circuit protection
	X1~X6	Multi-functional input terminals 1 ~ 6	Input specification: 24VDC,5mA Frequency range: 0~200Hz Voltage range: 24V±20%
	X7/DI	Multi-functional input or pulse input	Multi-functional input: same as X1~X6 Pulse input: 0.1Hz~10kHz; voltage range: 24V±20%
	CM	+24V grounding	Internal isolated with GND
Digital output	Y1	Open collector output	Voltage range: 24V±20%, maximum input current: 50mA
	CM	Open collector output common end	Internal isolated with GND
Analog input	+10V	Analog input reference voltage	10V ±3%, internal isolated with COM, Maximum output current: 10mA, with short circuit and overload protection
	AI1	Analog input channel 1	0~10V: Input impedance 20kΩ, maximum input voltage : 15V Resolution: 10 bits (0.025%)
	AI2	Analog input channel 2	0~20mA: Input impedance 500Ω, maximum input current: 30mA 0~10V: Input impedance 20kΩ, maximum input voltage : 15V Resolution: 10 bits (0.025%) 0~20mA or 0~10V analog input can be selected through jumper.
	GND	Analog grounding	Internal isolated with COM
Analog output	AO1	Analog output 1	0~20mA: allowable output impedance 200~500Ω 0~10V: allowable output impedance ≥10kΩ Output precision: 2%, resolution: 10 bits (0.1%) with short circuit protection function, 0~20mA or 0~10V analog output can be selected through jumper.
	AO2	Analog output 2	0~20mA: allowable output impedance 200~500Ω 0~10V: allowable output impedance ≥10kΩ Output precision: 2%, resolution: 10 bits (0.1%) with short circuit protection function, 0~20mA or 0~10V analog output can be selected through jumper.



	GND	Analog grounding	Internal isolated with COM
Relay output	A1/B1/C1	Relay output	A1—B1: Normally open C1—B1: Normally closed Contact capacity: 250VAC/1A, 30VDC/1A

Note: * If the user connects adjustable potentiometer between +10V and GND, the resistance of the potentiometer shall be no less than 5kΩ,

Note:

1. The arrangement sequence of the control circuit terminals is as follows:



3.9 Lectotype of Control Circuit Peripheral Devices

Terminal number	Terminal screw	Tightening torque (N·m)	Wire specification mm ²	Wire type
+10V, AI1, AI2, 485+, 485-, AO1, AO2, GND	M3	0.5~0.6	0.75	Twinning shielding cable
+24V, X1, X2, X3, X4, X5, X6, X7/DI, CM, Y1, CM, A1, B1, C1	M3	0.5~0.6	0.75	Shielding cable

3.10 Description of Jumper Function

Jumper selecting switch in Fig.3-7:

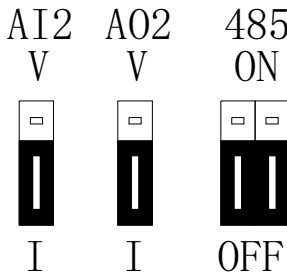

Name	Function	Leave-factory setting
AI2	I is the current input (0~20mA), V is the voltage input (0~10V)	0~20mA
AO2	I is the current input (0~20mA), V is the voltage input (0~10V)	0~20mA
485	485 terminal resistor selection: ON: there is 100Ω terminal resistor, OFF: there is no terminal resistor	There is no terminal resistor

Chapter 4 Using Instructions of Operation Panel

4.1 Introduction to Operation Panel



Shuttle type operation pane (SY8600-DP01)



















Analog type operation pane (SY8600-DP02)

Fig. 4-1 Display unit of operation panel

4.2 Descriptions of Indicators

Symbol of	Name	Meanings	Color
Hz	Frequency indicator	On: Current display parameter is running frequency	red
A	Current indicator	On: Current display parameter is current	red
V	Voltage indicator	On: Current display parameter is voltage	red
Hz+A	Rotating speed indicator	On: Current display parameter is rotating speed	red
A+V	Time indicator	On: Current display parameter is time	red
Hz+A+V	% indicator	On: Current display parameter is rotating	red
	No unit indicator	Off: Current display parameter is no unit	-
L/R	Running command reference mode indicator	On: Running command is given via operation panel Off: Running command is given via terminals Flash: Running command is given via host computer	red
RUN	Running status indicator	On: Inverter is running Off: Inverter has stopped Flash: Inverter is stopping	green
F/R	Run forward indicator	On: In stop status, inverter has run forward command; In running status, inverter is running forward Flash: Changing from running forward to running reverse	red
TRIP	Fault/Alarm indicator	ON: Normal condition Off: Fault condition Flash: Alarm	red

4.3 Description of Keys on Operation Panel

Symbol		Name	Function
Analog type	Shuttle-type		
		Programming key PRG	1、 Switch between program and other states, which includes parameters display and programming; In menu status, press this key to return previous menu.
		Function Selection/Save SET	1、 In program status, press this key to enter next menu. 2、 In menu level 3, press this key to save parameters value.
	Increase + 	Increase Key 	1、 In first level menu, increase function code PX according to edit bit 2、 In second level menu, increase the function code PX YZ data. 3、 In third level menu ,increase the function code data
	Decrease - 	Decrease 	1、 In first level menu, decrease function code PX according to edit bit 2、 In second level menu, decrease the function PX YZ code data 3、 In third level menu ,decrease the function code data
		Shift 	1、 In third level menu , use key >> to shift edit bit of the data 2、 In stop/run status, switch the panel display parameters such as frequency, current and voltage.
		Run Key RUN	1、 When running command is given via operation panel, the key is used to control the start of inverter. 2、 After setting the parameter auto tuning,start parameter auto tuning for inverter startup
		Stop/Reset Key STOP/RST	1、 When running command is given via operation panel, the key is used to control the stop of inverter. 2、 When the inverter has fault and has stopped, this key is used as RESET key to clear the fault alarm.
		Multi-function Key MF	0: Nonfunction; 1: Reversal
		JOG KEY JOG	Press this key to start jog operation, release this key to stop the drive.

4. 4 Keypad Operating Status

4. 4. 1 Initialization after power on

When the power is switched on, panel will start 5 seconds' initiation process. During this process, LED displays "8.8.8.8.", and all LED indicators on the panel are in ON state

4. 4. 2 Stopping State

In stopping state, LED displays default parameters in flashing mode, and the unit indicator in right side displays the unit of this parameters. In this state, all status indicators are OFF, press **▶▶** key ,LED displays fault code "n-xx" (xx=00-08),press **SET** key to enter and view the parameter; press **PRG** key to exit; and press **▶▶** key to scroll through parameters in stopping state.

4. 4. 3 Running state

In stopping state, after receiving running command, the drive enters running state. The LED and unit indicator display parameter and its unit respectively.

At this time, running status indicator is ON all the time. Press **PRG** key to enter programming menu and view parameter value.

Press **▶▶** key, LED displays running parameter "r-xx" (xx=00~14). Press **SET** key to enter and view parameter value; press **PRG** key to exit this parameter menu; press **▶▶** key to scroll through monitoring parameters.

4. 4. 4 Fault alarm state

In stopping, running or programming state, correspondent fault information will be reported if fault is detected. At this time, LED displays the fault code in flashing mode. When fault alarm occurs, press **PRG** key to enter programming menu and look up the fault log.

When fault alarm occurs, the alarm picture is displayed, and the fault can be reset by press **STOP/RESET** key. The drive restores to normal operation upon clearing the fault, and the fault code is displayed again if the fault has not been cleared.

4.5 Panel Operation Method

4.5.1 Panel Operation Procedure

Parameter setting method via panel: through three-level menu, users can look up and modify the function codes very easily.

Three level menu structure: function parameters (first level) → function codes(second level) → value of function code(third level). Operation process is shown in Fig.4-1.

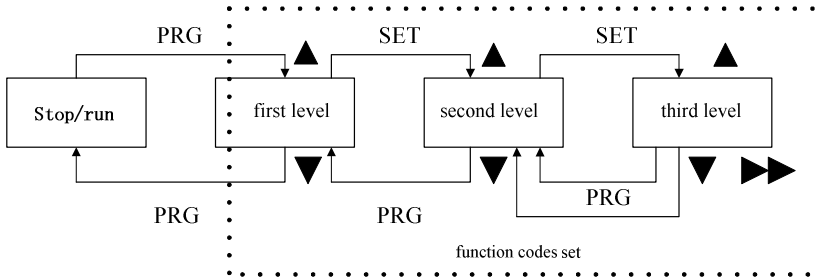

Fig.4-1 Menu Operation Procedure

In the third level menu, user can return second level menu by pressing **PRG** key or **SET** key. The difference is: Parameter settings can be saved in control board if **SET** key is pressed, then LED returns to second level menu and shifts to next function code automatically; If user presses **PRG** key, LED returns to second level menu directly, but the parameters can not be saved and stop at current function code.

4.5.2 Parameter setup

Setting parameters correctly is a premise for actualizing SY8600's performances. Parameter setting method via panel will be introduced in the following part with rated power as an example (Change 18.5kW into 7.5kW).

Operation process is shown in Fig.5-2. Press the **SHIFT** key with single direction shifting function to shift the flashing bit of parameters (that is modification bit). After finishing the parameters setup, press the **MENU** key twice to exit programming state.

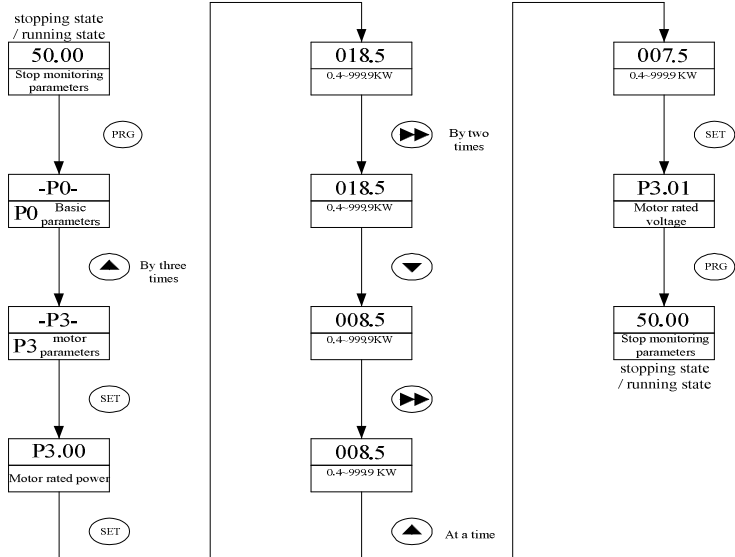

Fig 4-2 Procedure of parameter setup

4.6 Parameter Display

In stopping state or running state, various state parameters can be displayed by LED. The displayed parameters can be decided by PH.00 ~ PH.01 and can be scrolled through by pressing the **SHIFT** key. The following is an explanation for the parameters operation method in stopping and running state.

4.6.1 Switch of Parameter Display in Stopping State

In stopping state, the drive has 9 state parameters which can be scrolled by **SHIFT** key, they are: frequency setting, external counting value, digital value input terminal state, digital value output terminal state, panel potentiometer, analog input AI1, analog input AI2 and DC bus voltage. Please refer to the explanation of PH.01.

The default value of PH.01 is "preset frequency". If PH.01 value is set to 2, default display parameter in stopping state will be changed into "DC bus voltage".

User can look up other parameters during stopping state by pressing **SHIFT** key: Everytime you press **SHIFT** key, the next parameter in stopping state will be displayed.

4.6.2 Switch of the running parameters

In running state, maximum 15 running state parameters can be displayed by SY8600 drive via **SHIFT** key.

4.7 Motor auto-tuning procedure

Before selecting vector control mode, user should input motor parameters correctly. SY8600 drive can get motor's standard parameters according to the parameters on nameplate; In order to get better control performance, you can control the drive to perform auto-tuning on the motor, so as to get accurate motor parameters. Parameter tuning can be done through P3.05.

1. Set F0.01 parameter to 0 to select panel running command control mode;
2. According the motor's name-plate, Set P3.00、 P3.01、 P3.02、 P3.03、 P3.04 parameter in proper order.
3. Set P3.05 to 1, Select static auto-tuning, Or set P3.05 to 2, Select overall auto-tuning , Press "SET" key.
4. Press RUN key to start motor auto-tuning, After tuning, the motor stops.

4.8 Running for the First Time

Please follow the procedures to run the inverter for the first time:

Note:

- ◆ If fault happens, please judge the fault causes and clear the fault according to 7.1 Fault and alarm information list.
- ◆ If motor can without connecting the load rotating auto tuning can be selected (P3.05=2), otherwise only static auto tuning can be selected. When enabling the auto tuning please ensure the motor is in standstill status. If over voltage or over current happens in auto tuning process, you can prolong the acceleration and deceleration times of P0.16 and P0.17.

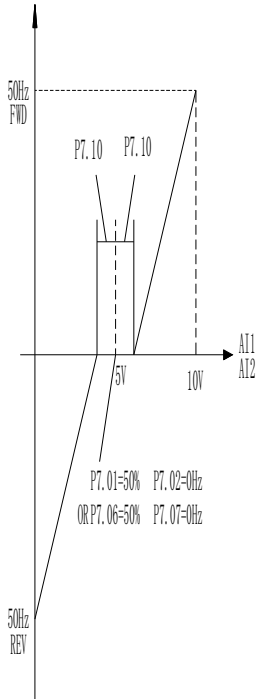

Chapter 5 List of Parameters

Meanings of Each Item in Function Code Parameter Table

Item	Meanings
Function code number	The number of function code, such as P0.00
Function code name	The name of function code, which explains the function code's meanings.
Function code selection	Function code parameter setting list
Factory setting	Restore the settings of the function code after the product is delivered (see P0.19).
Order number	The order number of function code
Property	#: This function code can be changed during operation; +: This function code can only be changed during stopping status; *: The setting of this function code is read-only and cannot be changed.

5.1 Function Parameter Table

Function code	Name	Description	Factory setting	Order number	Property
P0 Group Basic parameter					
P0.00	reserved			0	*
P0.01	Running command selection	0: Keypad control 1: External terminal 2: Communication	0	1	+
P0.02	Control mode	0: open loop vector control 1: V/F control	1	2	+
P0.03	Main Frequency Source	0: Panel setting 1: External analog signal AI1(0~10V) 2: External analog signal AI2(0~10V) or 0~20mA 3: up/down 1 setting 4: up/down 1 setting 5: Pulse frequency setting 6: Multi Frequency 7: PID 8: Communication setting mode 9: Program run	0	3	+



		10: Panel potentiometer setting (0~5V)			
P0.04	Main Frequency gain	0.000-9.999	1.000	4	+
P0.05	Zero frequency source of multi-speed mode	0: Digital frequency of P0.11 1: External analog signal: AI1 2: External analog signal: AI2 3: Panel potentiometer setting (0~5V)	0	5	+
P0.06	Auxiliary frequency source	0: External analog signal: AI1(0~10V) 1: External analog signal: AI2(0~10V) or 0~20mA 2: External analog signal: AI1(0~10V) (+/- polarity) 3: External analog signal: AI2 AI2(0~10V) or 0~20mA (+/- polarity) 4: pid	0	6	+
P0.07	Auxiliary frequency range selection	0: Maximum output frequency 1: Main frequency	0	7	+
P0.08	Auxiliary frequency range	0-100%	100	8	+
P0.09	Setting Frequency selection	0: Main frequency 1: Auxiliary frequency 2: Main frequency + Auxiliary frequency 3: Main frequency - Auxiliary frequency 4: switch between Main frequency and Auxiliary frequency 5: switch between Main frequency and (Main frequency + Auxiliary frequency) 6: switch between Main frequency and (Main frequency - Auxiliary frequency) 7: MAX (Main frequency , Auxiliary frequency) 8: MIN (Main frequency , Auxiliary frequency) 9: Traverse operation	0	9	+
P0.10	up/down setting store selection	0: Store 1: Not Store	0	10	#

P0. 11	Digital frequency setting	0~400.0Hz	50.00	11	#
P0. 12	Rotating direction (Keypad operation)	0: FWD 1: REV	0	12	+
P0. 13	Maximum output frequency	50.00~400.0 Hz	50.00	13	+
P0. 14	High frequency limit	0.00~ Maximum output frequency	50.00	14	+
P0. 15	Low frequency limit	0.00Hz~ High frequency limit	0	15	+
P0. 16	Acc time 1	0.1~3600.0s	20.0	16	#
P0. 17	Dec time 1	0.1~3600.0s	20.0	17	#
P0. 18	Inverter type select	0: General load mode 1: light load mode (for fan,pump)	0	18	+
P0. 19	Parameter initialization	0: No operation 1: Clear fault information 2: Recover factory setting Note: After executing 1~2 steps, restores to zero automatically.	0	19	+
PI Group Auxiliary function parameters 1					
P1. 00	Starting mode	0: Start from starting frequency 1: First braking then restart from starting frequency 2: Speed trace starting	0	20	+
P1. 01	Starting frequency	0.50~20.00Hz	0.50	21	+
P1. 02	Hold time of Starting Frequency	0.0~60.0s	0	22	+
P1. 03	DC injection braking time at start	0.0~60.0s	0	23	+
P1. 04	DC injection braking current start	0.0~100.0%(motor rated current)	0	24	+
P1. 05	Stopping mode	0: Dec-to-stop	0	25	+

		1: Dec-to-stop + DC braking 2: Free run to stop			
P1.06	Initial frequency of DC injection braking	0.00~20.00Hz	0	26	+
P1.07	DC injection braking time	0: No operation 0.1~60.0s	0	27	+
P1.08	DC injection braking current	0.0~100.0%(motor rated current)	0	28	+
P1.09	Acc/Dec mode selection	0: Linear mode 1: reserved	0	29	+
P1.10	Time of S curve' s start part	10.0%~50.0%	20.0%	30	+
P1.11	Time of S curve' s rising part	10.0%~80.0%	60.0%	31	+
P1.12	Restart after power failure	0: disabled 1: enabled	0	32	+
P1.13	Delay time for restarting after power failure	0.0~20.0s	2.0	33	+
P1.14	dynamic braking start voltage	630-710	660	34	
P1.15	Rate of dynamic braking	0: No dynamic braking 1~100%	90	35	#
P1.16	Action on frequency lower than lower frequency limit	0: dormancy 1: start, running at lower frequency limit 2: Stop	0	36	+
P1.17	MF key function	0: No operation; 1: reverse rotation	0	37	+
P1.18	Stop/reset Key function	0: action on keypad control mode 1: action on both keypad and External terminal 2: action on both keypad and communication	0	38	+



P1. 19	Fan control function	0: always run after power on 1: stop fan after inverter stop running	1	39	+
P2 Group Auxiliary function parameters 2					
P2. 00	Acc time 2	0.1~3600s	20.0	40	#
P2. 01	Dec time 2	0.1~3600s	20.0	41	#
P2. 02	Acc time 3	0.1~3600s	20.0	42	#
P2. 03	Dec time 3	0.1~3600s	20.0	43	#
P2. 04	Acc time 4	0.1~3600s	20.0	44	#
P2. 05	Dec time 4	0.1~3600s	20.0	45	#
P2. 06	Jog Acc time	0.1~20.0s	10.0	46	#
P2. 07	Jog Dec time	0.1~20.0s	10.0	47	#
P2. 08	Jog frequency	0.50~60.00Hz	5.00	48	#
P2. 09	Multi-frequency 1	0.00~400.0 Hz	0.00	49	#
P2. 10	Multi-frequency 2	0.00~400.0 Hz	0.00	50	#
P2. 11	Multi-frequency 3	0.00~400.0 Hz	0.00	51	#
P2. 12	Multi-frequency 4	0.00~400.0 Hz	0.00	52	#
P2. 13	Multi-frequency 5	0.00~400.0 Hz	0.00	53	#
P2. 14	Multi-frequency 6	0.00~400.0 Hz	0.00	54	#
P2. 15	Multi-frequency 7	0.00~400.0 Hz	0.00	55	#
P2. 16	Multi-frequency 8	0.00~400.0 Hz	0.00	56	#
P2. 17	Multi-frequency 9	0.00~400.0 Hz	0.00	57	#
P2. 18	Multi-frequency 10	0.00~400.0 Hz	0.00	58	#
P2. 19	Multi-frequency 11	0.00~400.0 Hz	0.00	59	#
P2. 20	Multi-frequency 12	0.00~400.0 Hz	0.00	60	#
P2. 21	Multi-frequency 13	0.00~400.0 Hz	0.00	61	#
P2. 22	Multi-frequency 14	0.00~400.0 Hz	0.00	62	#
P2. 23	Multi-frequency 15	0.00~400.0 Hz	0.00	63	#
P2. 24	Jump frequency 1	0.00~400.0 Hz	0.00	64	+
P2. 25	Jump frequency 2	0.00~400.0 Hz	0.00	65	+
P2. 26	Jump frequency 3	0.00~400.0 Hz	0.00	66	+

P2. 27	Jump frequency range	0.00~20.00 Hz	0. 00	67	+
P2. 28	FWD/REV dead time	0.0~3600s	0. 5	68	+
P2. 29	REV prohibited	0: REV enabled 1: REV disabled	0	69	+
P2. 30	Carrier frequency	2.0~12.0KHz	3. 0	70	+
P2. 31	Zero frequency threshold	0.0~400.0Hz	0. 00	71	+
P2. 32	Zero frequency hysteresis	0.0~400.0 Hz	0. 00	72	+
P2. 33	Droop control	0. 00~10. 00Hz	0. 00	73	+
P3 Group motor parameters					
P3. 00	Motor rated power	0.4~999.9KW	Drive's rated power	74	+
P3. 01	Motor rated voltage	0~440V	380V	75	+
P3. 02	Motor rated current	0.1~999.9A	Drive's rated value	76	+
P3. 03	Motor rated frequency	1.00~400.0Hz	50. 00	77	+
P3. 04	Motor rated speed	1~9999RPM	1440	78	+
P3. 05	Motor auto-tuning	0: No operation 1: static auto tuning 2: overall auto- tuning	0	79	+
P3. 06	Stator resistance	0.001-20.00%	Motor parameter	80	+
P3. 07	Rotor resistance	0.001-20.00%	Motor parameter	81	+
P3. 08	Self inductance	1. 000-9. 999	Motor parameter	82	+
P3. 09	Leakage inductance	0. 001-1. 000	Motor parameter	83	+
P3. 10	Exciting current with	0.0~999.9A	Motor	84	+

	no load		parameter		
P3.11	reserved			85	+
P4Group V/F control					
P4.00	V/f control mode	0: Linear V/F 1: Square V/F 2: 1.5 times torque 3: 1.2 times torque 4: User defined V/f	0	86	+
P4.01	Base voltage	0~440V	380	87	+
P4.02	Base frequency	10.00~400.0 Hz	50.00	88	+
P4.03	Intermediate voltage 1	0~P4.04	32	89	+
P4.04	Intermediate voltage 2	P4.03~100%	50	90	+
P4.05	Intermediate frequency 1	0~P4.06	16.00	91	+
P4.06	Intermediate frequency 2	P4.05~400.0Hz	25.00	92	+
P4.07	Torque boost	0.0~20.0% base voltage	3.0	93	+
P4.08	Slip compensation	0.0~10.0%(rated speed)	0.00	94	+
P4.09	AVR function	0: disabled 1: enabled	0	95	+
P5 Group VC control					
P5.00	ASR proportional gain 1	0.000~6.000	2.000	96	+
P5.01	ASR integration time 1	0.000~9.999	0.500	97	+
P5.02	ASR proportional gain 2	0.000~6.000	1.000	98	+
P5.03	ASR integration time 2	0.000~9.999	1.000	99	+
P5.04	ASR switching	00.00~99.99Hz	5.00	100	+

	frequency				
P5.05	Slip compensation gain	50.0~200.0%	100.0	101	+
P5.06	Driving torque limit	0~200.0% (motor rated current)	150.0	102	+
P5.07	Braking torque limit	0~200.0% (motor rated current)	150.0	103	+
P5.08	reserved			104	+
P5.09	reserved			105	+
P5.10	reserved			106	+
P6 Group I/O parameters					
P6.00	FWD/REV mode	0: Two-line operation mode 1 1: Two-line operation mode 2 2: 3-line operation mode 1 3: 3-line operation mode 2	0	107	+
P6.01	Up/down rate	0.10~99.99Hz/s	1.00	108	#
P6.02	Definition of input terminal X1	0 No function 1: FWD 2: REV	1	109	+
P6.03	Definition of input terminal X2	3: External reset 4: Jog FWD	2	110	+
P6.04	Definition of input terminal X3	5: Jog REV 6: Multi-frequency 1 7: Multi-frequency 2	3	111	+
P6.05	Definition of input terminal X4	8: Multi-frequency 3 9: Multi-frequency 4	4	112	+
P6.06	Definition of input terminal X5	10: Terminals for selecting Acc/Dec time 1 11: Terminals for selecting Acc/Dec time 2 12: Normally open terminal for inputting	5	113	+
P6.07	Definition of input terminal X6	external fault 13: Normally close terminal for inputting external fault	16	114	+
P6.08	Definition of input terminal X7	14: Frequency increase command 15: Frequency decrease command 16: Free run to stop 17: Three-wire control 18: switch of speed given mode 19: Reset terminal for program operation	0	115	+



		20: Start traverse operation 21: pause traverse operation 22: DC braking command 23: Acc/Dec disabled command 24: switch between panel control mode and external terminal control mode 25: switch between panel control mode and communication control mode 26: Counter trig signal 27: Counter reset signal 28: PID dormancy waking up 29: switch between PID positive mode and negative mode 30: emergence stop			
P6.09	Programmable relay 1	0: No function	17	116	+
P6.10	Output terminal Y1 definition	1: Drive ready 2: Drive running signal 1 3: Drive running signal 1 4: Frequency arriving signal 5: Frequency detection threshold 1 6: Frequency detection threshold 2 7: High limit frequency arriving 8: Low limit frequency arriving 9: Overload signal 10: Over voltage stall 11: Over current stall 12: External stopping command 13: Preset counting value arriving 14: Specified counting value arriving 15: Low voltage lockup signal 16: Overload pre-alarm 17: Drive failure signal 18: Zero speed running 19: end signal of stage of program operation 20: end signal of cycle of program operation	1	117	+
P6.11	Frequency arriving width	0.00~10.00Hz	0.00	118	#
P6.12	FDT1 level	0.00~400.0 Hz	50.00	119	#



P6. 13	FDT1 lag	0.00~10.00Hz	0. 00	120	#
P6. 14	FDT2 level	0.00~400.0 Hz	25. 00	121	#
P6. 15	FDT2 lag	0.00~10.00Hz	0. 00	122	#
P6. 16	Preset value arriving	0~9999	0	123	+
P6. 17	Specified value arriving	0~9999	0	124	+
P6. 18	Terminal logic	0~255	0	125	+
P7 Group Analog input terminal					
P7. 00	AI1 Filter time	0.05~5.00s	0. 50	126	#
P7. 01	Minimum AI1	0.0~100.0%	0. 0	127	#
P7. 02	Frequency corresponding to F7.02	0.00~100.0% (Maximum output frequency)	0. 00	128	#
P7. 03	Maximum AI1	0.0~100.0%	100. 0	129	#
P7. 04	Frequency corresponding to F7.06	0.00~100.0% (Maximum output frequency)	100.0	130	#
P7. 05	AI2 filter time	0.05~5.00s	0. 50	131	#
P7. 06	Minimum AI2	0.0~100.0%	0. 0	132	#
P7. 07	Frequency corresponding to F7.11	0.00~100.0% (Maximum output frequency)	0. 00	133	#
P7. 08	Maximum AI2	0.0~100.0%	100. 0	134	#
P7. 09	Frequency corresponding to F7.08	0.00~100.0% (Maximum output frequency)	100.0	135	#
P7. 10	FWD/REV dead time range	0.0~10.0%	1. 0	136	+
P7. 11	pulse frequency filter time	0.05~5.00s	0. 50	137	#
P7. 12	Minimum pulse frequency	0.0~100.0%	0. 0	138	#

P7.13	Frequency corresponding to F7.12	0.00~100.0% (Maximum output frequency)	0.00	139	#
P7.14	Maximum pulse frequency	0.0~100.0%	0.0	140	#
P7.15	Frequency corresponding to F7.14	0.00~100.0% (Maximum output frequency)	100.0	141	#
P8 Group Analog output terminal					
P8.00	AO1 output selection	0: Running frequency	1	142	#
P8.01	AO2 output selection		1	143	#
		1: Frequency setting 2: Output current 3: Output voltage 4: Output torque 5: DC Bus Voltage 6: PI reference 7: PI feedback 8: AI1 9: AI2			
P8.02	Minimum AO1	0.0~100.0%	0.0	144	#
P8.03	Minimum value corresponding to F8.02	0.0~100.0%	0.0	145	#
P8.04	Maximum AO1	0.0~100.0%	100.0	146	#
P8.05	Maximum value corresponding to F8.05	0.0~100.0%	100.0	147	#
P8.06	Minimum AO2	0.0~100.0%	0.0	148	#
P8.07	Minimum value corresponding to F8.06	0.0~100.0%	0.0	149	#
P8.08	Maximum AO2	0.0~100.0%	100.0	150	#
P8.09	Maximum value	0.0~100.0%	100.0	151	#

	corresponding to F8.08				
P9 Group program operating parameters					
P9.00	Programming operation function	0: Single cycle (Stop after a single cycle) 1: Continuous cycle 2: Maintain the final value	0	152	+
P9.01	Time Unit	0: Second 1: Minute	0	153	+
P9.02	Stage 1 timing T1	0~3600.0	0	154	+
P9.03	Stage 2 timing T2	0~3600.0	0	155	+
P9.04	Stage 3 timing T3	0~3600.0	0	156	+
P9.05	Stage 4 timing T4	0~3600.0	0	157	+
P9.06	Stage 5 timing T5	0~3600.0	0	158	+
P9.07	Stage 6 timing T6	0~3600.0	0	159	+
P9.08	Stage 7 timing T7	0~3600.0	0	160	+
P9.09	Stage 8 timing T8	0~3600.0	0	161	+
P9.10	Stage 9 timing T9	0~3600.0	0	162	+
P9.11	Stage 10 timing T10	0~3600.0	0	163	+
P9.12	Stage 11 timing T11	0~3600.0	0	164	+
P9.13	Stage 12 timing T12	0~3600.0	0	165	+
P9.14	Stage 13 timing T13	0~3600.0	0	166	+
P9.15	Stage 14 timing T14	0~3600.0	0	167	+
P9.16	Stage 15 timing T15	0~3600.0	0	168	+
P9.17	T1 running mode	0: FWD, Acc/Dec time 1	0	169	+
P9.18	T2 running mode	1: FWD, Acc/Dec time 2	0	170	+
P9.19	T3 running mode	2: FWD, Acc/Dec time 3	0	171	+
P9.20	T4 running mode	3: FWD, Acc/Dec time 4	0	172	+
P9.21	T5 running mode	4: REV, Acc/Dec time 1	0	173	+
P9.22	T6 running mode	5: REV, Acc/Dec time 2	0	174	+
P9.23	T7 running mode	6: REV, Acc/Dec time 3	0	175	+

P9. 24	T8 running mode	7: REV, Acc/Dec time 4	0	176	+
P9. 25	T9 running mode		0	177	+
P9. 26	T10 running mode		0	178	+
P9. 27	T11 running mode		0	179	+
P9. 28	T12 running mode		0	180	+
P9. 29	T13 running mode		0	181	+
P9. 30	T14 running mode		0	182	+
P9. 31	T15 running mode		0	183	+
P9. 32	Record function		0: Disabled 1: Record, not store after power off 2: Record, store after power off	0	184
PA Group PID parameters					
PA. 00	PID control characteristic	0: Positive characteristic 1: Negative characteristic	0	185	+
PA. 01	Reference selection	0: Panel Digital setting 1: External analog signal AI1 2: External analog signal AI2 3: Communication 4: Panel potentiometer setting (0~5V)	0	186	+
PA. 02	Feedback channel selection	0: External analog signal AI1 1: External analog signal AI2	0	187	+
PA. 03	Digital setting of reference	0.00~10.00V	5.00	188	#
PA. 04	Minimum reference	0~100%	0	189	+
PA. 05	Maximum reference	0~150%	100	190	+
PA. 06	Minimum feedback	0~100%	0	191	+
PA. 07	Maximum feedback	0~150%	100	192	+
PA. 08	Proportional gain	0.00~10.00	1.00	193	#
	Integration time	0.01~99.99s	0.5	194	#

PA. 10	Differential time	0.00, no differentiation 0.01~99.99s	0	195	#
PA. 11	Sample cycle	0.01~99.99s	0.1	196	#
PA. 12	Error limit	0.0~15.0%	0.0	197	#
PA. 13	Level of abnormal feedback signal	0~100%	50	198	#
PA. 14	Detection time of abnormal feedback signal	0: No detection 0.1~3600s	0.0	199	#
PA. 15	reserved		0	200	+
PA. 16	PID Sleep control	0: No sleep function; 1: Internal waking up, 2: External input terminal	0	201	+
PA. 17	Delay time of sleepin	0~3600s	0	202	+
PA. 18	Sleeping frequency	0.00~400.0Hz	0.00	203	+
PA. 19	Delay time of waking	0.0~60.0s	0.0	204	+
PA. 20	Waking value	0.0~100.0%	100.0	205	+
Pb GROUP Traverse operation parameters					
Pb. 00	Traverse mode	0: Auto mode 1: Manual mode	0	206	+
Pb. 01	Preset traverse frequency	0.00~400.0 Hz	0.00	207	#
Pb. 02	Hold time of preset traverse frequency	0.0~3600s	0.0	208	#
Pb. 03	Preset central frequency	0.00~400.0 Hz	0.00	209	#
Pb. 04	Travers amplitude	0.0~50.0% (Pb.03)	0.0	210	#
Pb. 05	Step frequency	0.0~50.0% (Pb.04)	0.0	211	#
Pb. 06	Traverse cycle	0.1~999.9s	10.00	212	#
Pb. 07	Rise time of triangular wave	0.0~100.0% (Pb.06)	50.0	213	#
PC Group 485 communication parameters					
PC. 00	Baud rate selection	0: 1200BPS	3	214	+

		1: 2400BPS 2: 4800BPS 3: 9600BPS 4: 19200BPS 5: 38400BPS			
PC. 01	Data format	0: 8,N,2 for RTU (MODBUS) 1: 8,E,1 for RTU (MODBUS) 2: 8,O,1 for RTU (MODBUS) 3: 7,N,2 for ASCII (MODBUS) 4: 7,E,1 for ASCII (MODBUS) 5: 7,O,1 for ASCII (MODBUS) 6: 8,N,1 free communication format 7: 8,E,1 free communication format 8: 8,O,1 free communication format 9: 8,N,2 for RTU (MODBUS) MASTER	0	215	+
PC. 02	Local address	1~32, 0 is the broadcast address	1	216	+
PC. 03	Communication timeout detect	0, No detection 2.0~10.0s	0	217	+
PC. 04	Response delay	2~1000ms		218	+
PC. 05	EEROM Store selection	0: Store 1: no store function	0	219	+
Pd Group Faults and protection parameters					
Pd. 00	Motor overload protection mode	0: No protection 1: Common motor protection 2: Variable frequency motor protection	1	220	+
Pd. 01	Motor overload protection factor	20.0~150.0%	100.0	221	+
Pd. 02	Over voltage stall selection	0: Disabled 1: Enabled	1	222	+
Pd. 03	Stall over voltage point	120.0~150.0%	120.0	223	+
Pd. 04	Selection of overload	0: Detect at constant speed and alarm	0	224	+

	pre-alarm detection	1: Detect all the time and alarm			
Pd. 05	Overload detection threshold	20.0~180.0%	150.0	225	+
Pd. 06	Overload pre-alarm delay	0.0~60.0s	2.0	226	+
Pd. 07	Auto current limiting threshold	20.0~180.0%	150.0	227	+
Pd. 08	Frequency decrease rate during current limiting	0.00~99.99 Hz/s	0.00	228	+
Pd. 09	Action mode of auto current limiting	0: Disabled 1: Enabled during Acc/Dec, disabled at constant speed 2: Enabled during Acc/Dec, enabled at constant speed	1	229	+
Pd. 10	Auto reset	0: Disabled 1~5: Times of fault reset	0	230	+
Pd. 11	Auto reset interval	2.0~20.0s	2.0	231	+
Pd. 12	Relay action in Auto reset	0: No action 1: action	0	232	
Pd. 13	Act selection at under voltage fault	0: No action 1: Act in running state 2: Act in running and stop state	1	233	+
Pd. 14	Input phase loss function	0: Disable 1: Enale	1	234	+
Pd. 15	Output phase loss function	0: Disable 1: Enale	1	235	+
Pd. 16	Under Voltage Point	360~440	400	236	+
Pd. 17	reserved			237	+
Pd. 18	reserved			238	+
Pd. 19	reserved			239	+

Pd. 20	reserved			240	+
PE Group group Reserve 1					
PF group Reserve 2					
PH Group Display parameters					
PH. 00	running display parameters selection	0: Frequency setting 1: Running frequency 2: Output current 3: Output voltage 4: Bus voltage 5: Overload rate 6: Preset line speed 7: Running line speed 8: Output torque 9: PI reference 10: PI feedback 11: Analog input AI1 12: Analog input AI2 13: I/O status 14: External counting value	1	267	#
PH. 01	Display parameters at stop	0: Frequency setting 1: Preset line speed 2: DC Bus voltage 3: Analog input AI1 4: Analog input AI2 5: I/O status 6: external counting value 7: PI reference 8: PI feedback	0	268	#
PH. 02	Line speed factor	0.01~99.99	30.00	269	#

PH. 03	Inverter Power			270	*
PH. 04	heatsink temperature 1	0~100		271	*
PH. 05	heatsink temperature 2	0~100		272	*
PH. 06	1st fault type			273	*
PH. 07	2nd fault type			274	*
PH. 08	3rd fault type			275	*
PH. 09	Bus voltage at last fault			276	*
PH. 10	Output current at last fault			277	*
PH. 11	Frequency setting at last fault			278	*
PH. 12	Running frequency at last fault			279	*
PH. 13	I/O state at last fault			280	*
PH. 14	Total operating time			281	*
PH. 15	Software version of CPU Board			282	*
PH. 16	Software version of Keypad Board			283	*

Chapter6 Detail Function Introduction

P0 Basic function parameters

P0.00 Reservation	
-------------------	--

P0.01 Running command selection	Setting range: 0, 1, 2
---------------------------------	------------------------

Select physical channel of inverter's running control command, common running commands include: Start, Stop, FWD and REV;

0: Running command issued by keypad

Running command is issued by pressing the keys on the keypad, such as RUN, STOP/RESET, JOG, etc.

1: Running command issued by External terminals

Running command is issued by external terminals, such as FWD, REV, JOGF and JOGR (terminal function must be defined).

2: Running command issued by RS485 serial communication port

Running command can be issued through internal RS485 serial communication port by host.

P0.02 Control mode	Setting range: 0~1
--------------------	--------------------

0: Sensorless vector control

That is no speed sensor vector control running mode, which can be used for high performance variable speed general driving condition.

Note:

- a. At the first running when vector control mode is selected, please perform motor auto-tuning to get accurate parameters of motor. After auto-tuning, motor parameters will be saved in the internal control board for control operation.
- b. To ensure high steady/dynamic control performance, user must set parameters of speed controller correctly. For parameters setup and adjustment of speed controller, please refer to explanation of P5 parameter group.
- c. If vector control mode is selected, one SY8600 can only drive one motor. At this time, motor capacity can be one level higher (full load is forbidden) or lower than that of the inverter. Difference of capacity between inverter and motor should not be too large, otherwise, the inverter's control performance drops or drive system cannot operate normally.

1: V/F control

When one inverter drives more than one motor, if motor auto-tuning cannot be performed or the motor's parameters cannot be acquired through other methods, please select V/F control mode.

P0.03 Main Frequency Source	Setting range: 0~10
-----------------------------	---------------------

SY8600 series inverter has ten kinds of frequency setting mode.

0: Keypad setting, In this mode, present frequency is set by the Shuttle knob on the panel.

1: External analog signal AI1 (0~10V)

Use external analog signal AI1 to set the running frequency

2: External analog signal AI2 (0~10V or 0-20mA) ,use S1(AI2) dial switch to determine

voltage/current signal

3: up/down 1 setting

Present frequency is set by terminal defined by up/down function. Frequency setting is held when the drive stops.

4: up/down 2 setting

Present frequency is set by terminal defined by up/down function. Frequency setting is the data of P0.11 when the drive stops.

5: Pulse frequency setting

6: *Multi Frequency*

You need to set relevant parameter of the P6 I/O and P2 ,When choose multi frequency operational mode

7: PID

8: RS485 setting

Frequency setting is set by host computer via RS485 serial communication command.

9: Program running

When inverter begins running,Need to set P9 parameter.

10: Panel potentiometer setting (0~5V)

P0.04 Main Frequency gain	Setting arrange: 0.000~9.999
---------------------------	------------------------------

The main frequency is the product of the setting frequency selected by parameter P0.03 and this gain.

P0.05 Zero frequency source of multi-speed mode	Setting arrange: 0~2
---	----------------------

0: P0.11Digital frequency setting

1: External analog signal AI1 setting

2: External analog signal AI2 setting

3: Panel potentiometer setting (0~5V)

P0.06 assist frequency setting	Setting arrange: 0~4
--------------------------------	----------------------

SY8600 series inverter has ten kinds of assist frequency setting mode

0: External analog signal AI1 (0~10V)

1: External analog signal AI2 (0~10V or 0-20mA) , use S1(AI2) dial switch to determine voltage/current signal

2: External analog signal AI1 (0~10V) with polarity control

3: External analog signal AI2 (0~10V or 0-20mA) with polarity control

4: PID

When P0.06=2, 3, Polarity control of external analog AI1 and AI2 is shown in Fig. 6-1, and dead zone of polarity is decided by parameter P7.10.

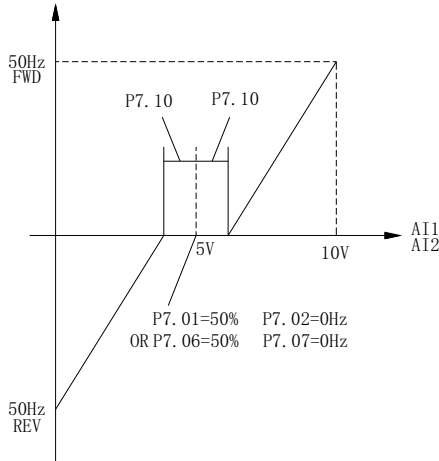

Fig6-1 Polarity control of external analog signal

P0.07 Auxiliary frequency range selection	Setting range: 0~1
---	--------------------

Selecting the range of the auxiliary frequency

0: Maximum output frequency

1: Main frequency

P0.08 Auxiliary frequency range	Setting range: 0~100%
---------------------------------	-----------------------

The auxiliary frequency is the product of the setting frequency selected by parameter P0.07 and this gain.

P0.09 Setting Frequency selection	Setting range: 0~9
-----------------------------------	--------------------

Select the setting frequency source of the inverter.

0: Main frequency

The setting frequency source of the inverter is determined by the main frequency of the parameter of P0.03.

1: Auxiliary frequency

The setting frequency source of the inverter is determined by the auxiliary frequency of the parameter of P0.06.

2: Main frequency + Auxiliary frequency

3: Main frequency - Auxiliary frequency

4: switch between main frequency and auxiliary frequency

The setting frequency source of the inverter can be switched between the main frequency and auxiliary frequency with the external terminal defined by P6 Group parameter.

switch between Main frequency and (Main frequency + Auxiliary frequency)

The setting frequency source of the inverter can be switched between the main frequency and (Main frequency + Auxiliary frequency) with the external terminal defined by P6 Group parameter.

6: switch between Main frequency and (Main frequency - Auxiliary frequency)

The setting frequency source of the inverter can be switched between the main frequency and (Main frequency - Auxiliary frequency) with the external terminal defined by P6 Group parameter.

7: MAX (Main frequency, Auxiliary frequency)

The setting frequency source of the inverter is maximum of main frequency and auxiliary frequency

8: MIN (Main frequency, Auxiliary frequency)

The setting frequency source of the inverter is minimum of main frequency and auxiliary frequency

9: Traverse operation

The setting frequency source of the inverter is determined by traverse operation mode defined by function code Pb parameter group.

P0.10 up/down setting store selection	Setting range: 0, 1
---------------------------------------	---------------------

0: Store

The initial frequency setting value is the value of parameter P0.11. It can be changed by the terminal defined with function “Frequency increase command” and “Frequency decrease command”. When the inverter is power off, the current frequency setting value is stored.

1: Not Store

The initial frequency setting value is the value of parameter P0.11. It can be changed by the terminal defined with function “Frequency increase command” and “Frequency decrease command”. When the inverter is power off, the current frequency setting value is not stored.

P0.11 digital frequency setting	Setting range: 0.00~High frequency limit
---------------------------------	--

If digital frequency setting via panel is selected, the value of parameter, will be the present preset frequency.

P0.12 Rotating direction	Setting range: 0, 1
--------------------------	---------------------

If panel control mode is selected, select the relationship between inverter's actual output direction and the direction of control command.

0: Same with control command;

1: Opposite to control command



P0.13	Maximum output frequency	Setting range: 50Hz~400.0Hz
P0.14	High frequency limit	Setting range: lower frequency limit ~ Maximum output frequency
P0.15	Low frequency limit	Setting range: 0.00Hz~Upper frequency limit

The maximum output frequency is the maximum frequency which the inverter is able to output, shown in Fig. 6-2 as F_{max} ;

High frequency limit is the maximum frequency which the user is allowed to set, shown in Fig. 6-2 as f_H ;

Low frequency limit is the minimum frequency which the user is allowed to set, shown in Fig. 6-2 as f_L ;

f_b in Fig.6-2 is basic running frequency, which is defined as the lowest output frequency when the inverter outputs the highest voltage in V/F control mode.

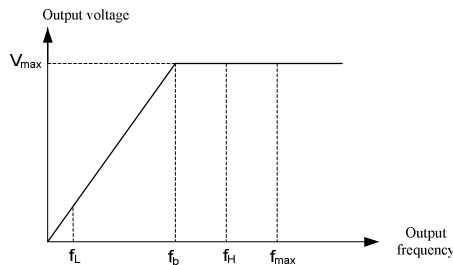

Fig.6-2 Frequency limits definition

P0.16 Acc time 1	Setting range: 0.1~3600s
P0.17 Dec time 1	Setting range: 0.1~3600s

Acc time means the time during which the inverter output from zero frequency to the maximum output frequency, shown in Fig. 6-3 as T_1 .

Dec time means the time during which the inverter outputs from the maximum output frequency to zero frequency, shown in Fig. 6-3 as T_2 .

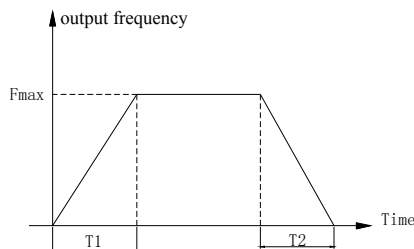

Fig 6-3 Definition of Acc/Dec tim

Factory setting of Acc/Dec time: Acc/Dec time 1 (P0.16、P0.17)。

Other Acc/Dec time must be selected through control terminals according to different groups (Please refer to P2 Parameter group).

When program is running, selection of Acc/Dec time group is setup in function code (Please refer to P9 Parameter group).

P0.18 Inverter type select	Setting range: 0, 1
----------------------------	---------------------

0: General –type inverter (for constant torque load)

1: Pump –type inverter (for fan, pump)

Some of the SY8600 series inverter combine the General-type and Pump-type into one device. The power of the motor of the General –type inverter is lower than Pump –type inverter. The default type is General –type inverter. If the user changes the inverter from General –type inverter to Pump –type inverter, he must do following steps:

1. Setting the parameter to 1.

2. Resetting the parameter P3.02(motor rated current).

P0.19 Parameter initialization	Setting range: 0~3
--------------------------------	--------------------

0: No operation

Inverter is in normal parameter read/write state.

1: Clear fault information

The fault information clearing operation will clear all the memorized parameters stored in the function codes between PH.06~PH.13

2: Recover factory setting

Setup F0.19 to 2 and confirm, inverter will recover all the parameters between P0~P2 and P4~PH to the default factory setting value.

All the setting values of P3 Parameter group will not be influenced when factory setting value is restored.

3: Parameter locking

When set P0.19 to 3, parameter locking function is enabled. Except this parameter, all other parameters are read only and can not be modified.

P1 Auxiliary function parameters 1

P1.00 start mode	Setting range: 0~2
------------------	--------------------

0: Start from starting frequency

When inverter begins running, it starts from starting frequency (P1.01) and runs for the preset time (P1.02) at this frequency according to the setting values of P1.01 and P1.02; then it enters normal Acc mode according to preset Acc time and Acc/Dec mode parameters, at last it accelerates to preset frequency.

1: Brake first then start from starting frequency

When inverter begins running, it starts DC injection braking process according to the preset DC injection braking voltage and time defined in P1.03 and P1.04. It starts from starting frequency, and runs for the preset time at this frequency; and then enters normal Acc mode according to preset Acc time and Acc/Dec mode parameters, and at last accelerates to preset frequency. The process is shown in Fig. 6-4.

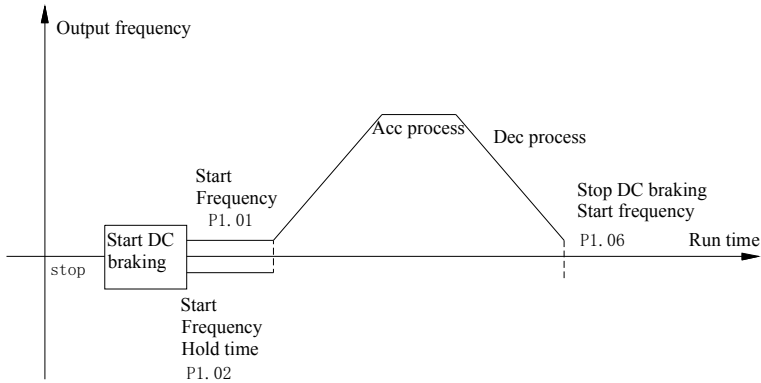

Fig. 6-4 Start mode 1 (FWD, REV, Stop and RUN) diagram

2: Speed trace starting

When the inverter begins running, first it detects the motor 's speed and direction, and then it starts smoothly at the detected speed and direction. Smooth start without impaction should be performed on rotating motor.

P1.01 Starting frequency	Setting range: 0.00~20.00Hz
P1.02 Hold time of starting frequency	Setting range: 0.00~60.0s

Start frequency: It is the initial frequency when the inverter starts from zero frequency, which is shown in Fig. 6-4.

In the Acc and Start process, if the preset frequency is lower than the start frequency, inverter's output frequency becomes zero;

Start frequency holding time: the running time at start frequency in Acc/Start process, which is shown in Fig. 6-4.

P1.03 DC injection braking time at start	Setting range: 0.00~60.0s
P1.04 injection braking current at start	Setting range: 0.0~100.0% (inverter rated current)

DC braking time at start: holding time for output DC injection braking current when the inverter is in start process.

If DC injection braking time at start is set to 0.0 second, DC injection braking function is disabled.

DC braking current at start: percentage of braking voltage when the inverter starts in DC injection braking process.

P1.05 Stop mode selection	Setting range: 0, 1, 2
---------------------------	------------------------

0: Dec-to-stop mode 1

When the inverter receives stop command, it lowers its output frequency and decelerates to stop according to the preset Dec time. During Dec process, for inverter with braking resistor or unit, it will enter dynamic braking.



1: Dec-to-stop mode 2

After the inverter receives stop command, it lowers its output frequency and decelerates to stop according to the preset Dec time. During Dec process, when output frequency is equal to the frequency set by P1.06, the inverter starts DC braking according to the DC braking time and voltage defined by P1.07 and P1.08.

2: Free run to stop

After the inverter receives the stop command, it stops its output immediately; the motor will decelerate to stop according to its inertia.

P1.06 Initial frequency of DC injection braking	Setting range: 0.00~20.00Hz
---	-----------------------------

Initial frequency of DC injection braking: It is the frequency when the inverter's output frequency is decreased to zero along the Dec curve in Dec-to-stop process, which is shown in Fig. 6-4.

In the process of Dec-to-stop, when the preset frequency is lower than the initial frequency of Stop DC injection braking, the inverter's output frequency is decreased to zero.

If the running condition has no strict requirements for braking, the initial frequency of DC injection braking should be set as low as possible.

P1.07 DC injection braking time	Setting range: 0.0, 0.1~60.0s
P1.08 DC injection braking current	Setting range: 0.0~100.0% (inverter's rated current)

DC injection braking time: the time for maintaining output DC injection braking in inverter's stopping process.

DC injection braking current: percentage of braking voltage when the inverter stops in DC injection braking mode.

When the DC injection braking time is set to 0 second., the DC injection braking function is disabled.

P1.09 Acc/Dec mode selection	Setting range: 0, 1
------------------------------	---------------------

Acc/Dec modes 0 and 1 are valid in Start, Stop, FWD/REV, Acc and Dec process.

0: linear mode

In Acc/Dec process, the relationship between output frequency and Acc/Dec time is linear. The output frequency increases or decreases at the constant slope as shown in Fig. 6-5.

1: S curve mode

In Acc/Dec process, the relationship between output frequency and Acc/Dec time is nonlinear. The output frequency increases or decreases according to the S curve shown in Fig. 6-6.

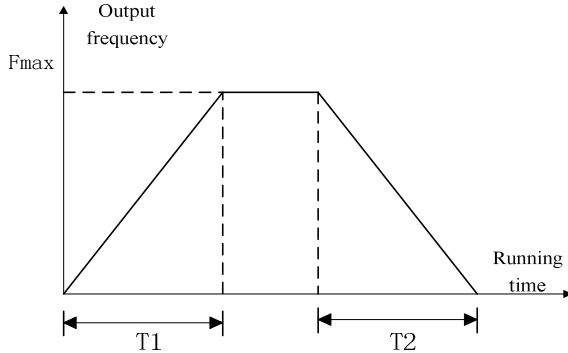

Fig. 6-5 linear Acc/Dec

1: S curve mode

In Acc/Dec process, the relationship between output frequency and Acc/Dec time is nonlinear. The output frequency increases or decreases according to the S curve shown in Fig. 6-6.

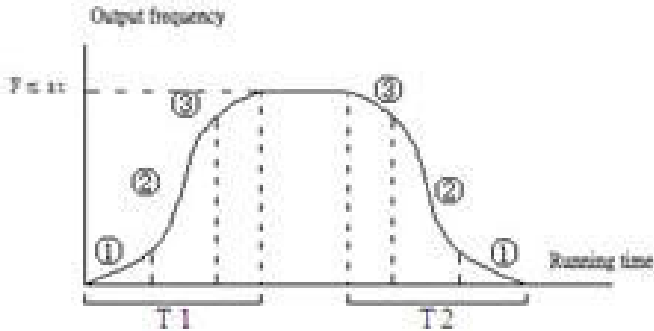

Fig. 6-6 S curve Acc/Dec

P1.10	Time of S curve's start part	Setting range: 10.0 ~ 50.0 % (Acc/Dec time)
P1.11	Time of S curve's rising part	Setting range: 10.0 ~ 80.0 % (Acc/Dec time)

The function codes of P1.10 and P1.11 define the Acc/Dec parameters of S curve.

S curve start time is shown in Fig. 6-6 as ①, which is the stage when the slope of output frequency rises gradually.

S curve rise time is shown in Fig. 6-6 as ②, which is the stage when the slope of output frequency maintains phase.

S curve end time is shown in Fig.6-6 as ③, which is the stage when the slope of output frequency decreases to zero.

Note:

Limit of setting value: S curve start time + S curve rise time ≤ 90 % (Acc/Dec time).

2. In Acc/Dec Process, the parameters of S curve are set in symmetry.

P1.12 Restart after power failure	Setting range: 0, 1
-----------------------------------	---------------------

0: Disabled;

1: Enabled; Function of restarting after power failure is enabled when the power supply recovers.

P1.13 Delay time for restarting after power failure	Setting range: 0.0~20.0s
---	--------------------------

When the power recovers from failures, the time before the inverter restarts is the delay time. This time is set according to the time needed by other equipment to recover when the power supply recovers.

P1.14 dynamic braking start voltage	Setting range: 630~710V
-------------------------------------	-------------------------

Setting the start voltage of dynamic braking.

P1.15 Rate of dynamic braking	Setting range: 0.0 ~100.0%
-------------------------------	----------------------------

Define duty cycle of dynamic braking.

0: No dynamic braking

1%~100%: In process of dynamic braking, percentage of valid braking time to carrier cycle, user can modify this value if necessary.

P1.16 Start frequency lower than frequency limit	Setting range:0, 1,2
--	----------------------

0:when preset frequency is lower than low frequency limit, the inverter will not start;

1:when preset frequency is lower than low frequency limit, the inverter will start at low frequency limit;

2:When preset frequency is lower than frequency limit, the inverter stop.

P1.17 MF key function	
-----------------------	--

0: No operation;

1: reverse rotation

P1.18 Stop/reset Key function	Setting range: 0、 1、 2
-------------------------------	------------------------

This parameter decides the “stop” function of STOP/RESET key of the keypad in different command source. The ” Reset” function is usable in all command source.

0: action on keypad control mode

1: action on both keypad and External terminal

2: action on both keypad and communication

P1.19 Fan control function	Setting arrange: 0、 1
----------------------------	-----------------------

0: Cooling fan always runs after power on

1: Cooling fan stops fan after inverter stop running

P2 Auxiliary function parameters 2

P2.00 ACC time2	Setting arrange: 0.1~3600s
P2.01 ACC time2	Setting arrange: 0.1~3600s
P2.02 ACC time3	Setting arrange: 0.1~3600s
P2.03 ACC time3	Setting arrange: 0.1~3600s

P2.04 ACC time4	Setting arrange: 0.1~3600s
P2.05 ACC time4	Setting arrange: 0.1~3600s

Four Acc/Dec times are defined as following:

Phases of Acc/Dec time		1	2	3	4
Terminal state	X4	OFF	ON	OFF	ON
	X5	OFF	OFF	ON	ON

As shown in the table above, in normal operation condition, Acc/Dec time 1 is the default setting (both terminals X4, X5 are OFF, and Acc/Dec time 1 and 2 are defined by terminal X4 and X5 respectively).

P2.06 Jog Acc time 1	Setting range: 0.1~20.0s
P2.07 Jog Dec time 1	Setting range: 0.1~20.0s
P2.08 Jog frequency	Setting range: 0, 1~60.00Hz

P2.06~P2.08 define the jog running parameters, which is shown in Fig. 8-7.

In Fig. 6-7, f_1 is Jog running frequency (P2.08), t_1 is Jog Acc time (P2.06), t_3 is Jog Dec time (P2.07), and t_2 is the Jog running time.

Jog running command can be issued through panel, control terminal or host computer.

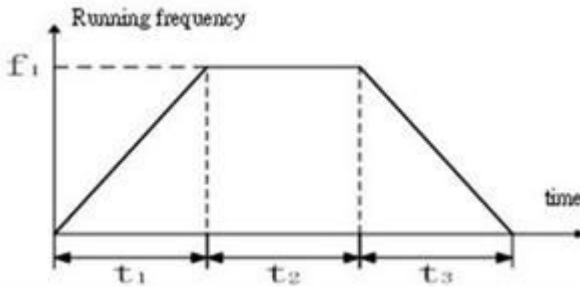

Fig. 6-7 Jog running parameters

P2.09 Multi-frequency 1	Setting range: 0~400.0Hz
P2.10 Multi-frequency 2	Setting range: 0~400.0Hz
P2.11 Multi-frequency 3	Setting range: 0~400.0Hz
P2.12 Multi-frequency 4	Setting range: 0~400.0Hz
P2.13 Multi-frequency 5	Setting range: 0~400.0Hz
P2.14 Multi-frequency 6	Setting range: 0~400.0Hz
P2.15 Multi-frequency 7	Setting range: 0~400.0Hz
P2.16 Multi-frequency 8	Setting range: 0~400.0Hz
P2.17 Multi-frequency 9	Setting range: 0~400.0Hz
P2.18 Multi-frequency 10	Setting range: 0~400.0Hz
P2.19 Multi-frequency 11	Setting range: 0~400.0Hz
P2.20 Multi-frequency 12	Setting range: 0~400.0Hz
P2.21 Multi-frequency 13	Setting range: 0~400.0Hz
P2.22 Multi-frequency 14	Setting range: 0~400.0Hz
P2.23 Multi-frequency 15	Setting range: 0~400.0Hz

Multi-frequency/speed is set in P2.09~P2.23, which can be used in multi-speed running and programming state.

There are 15 multi-frequency operation modes, which can be selected through control terminals.

Assumption:

“1 (ON)” means that control terminal is connected;

“0 (OFF)” means that control terminal is disconnected.

If control terminals of multi-frequency are not set, or all of them are in OFF position, frequency setting is determined by function code P0.02;

If certain control terminal of multi-frequency is not in OFF position, frequency setting is determined by function code P2.09~P2.23;

If multi-frequency operation is selected, Starting/stopping the drive is determined by control mode selection P0.01.

Frequency Terminal	1	2	3	4	5	6	7	8	9	10	11	12	13	14	15
Terminal 1	X	X	X	X	X	X	X	X	X	X	X	X	X	X	X
Terminal 2	1	0	1	0	1	0	1	0	1	0	1	0	1	0	1
Terminal 3	0	1	1	0	0	1	1	0	0	1	1	0	0	1	1
Terminal 4	0	0	0	1	1	1	1	0	0	0	0	1	1	1	1
Terminal 4	0	0	0	0	0	0	0	1	1	1	1	1	1	1	1

P2.24 Jump frequency 1	Setting range: 0~400.0Hz
P2.25 Jump frequency 2	Setting range:0~400.0Hz
P2.26 Jump frequency 3	Setting range:0~400.0Hz
P2.27 Jump frequency range	Setting range:0~20.00Hz

Jump frequency is set to prevent the output frequency of inverter from meeting the mechanical resonant point of load.

In Jump frequency parameters, set the system's mechanical resonant central frequency, at most three frequency values can be setup, shown in Fig.6-8.

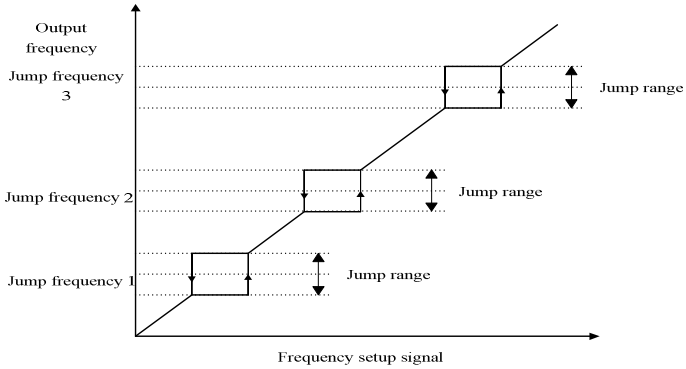

Fig. 6-8 Jump frequency and its range

p2.28 FWD/REV dead time	Setting range: 0.1~3600s
-------------------------	--------------------------

FWD/REV dead time: the waiting and holding time before the motor changes its rotating direction after the inverter's output frequency is decreased to zero. It is the time taken by the motor to change its rotating direction when the inverter receives REV command during its running process. The time is shown in Fig. 6-9 as T0.

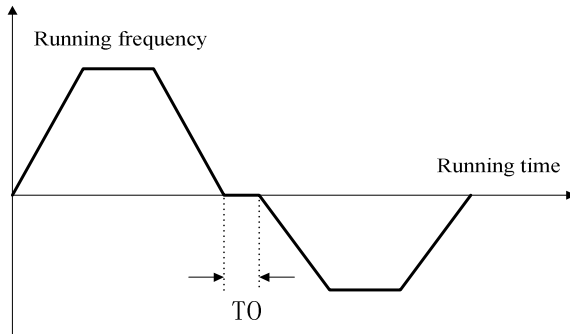

Fig. 6-9 FWD/REV dead time

P2.29 REV prohibited	Setting range: 0, 1
----------------------	---------------------

When P2.29=0, this function is disabled. In this case, terminal F/R=OFF, Run FWD; terminal F/R=ON, Run Rev;

When P2.29=1, this function is enabled. In this case, terminal F/R signal is invalid. Mtor can only run forward, and switching between FWD/REV is not available.

Running mode of routine program is independent of this function.

In traverse operation mode, both FWD and REV running are allowable, but switching between FWD/REV is prohibited. Setting FWD/REV direction may not be same as actual direction, which can be defined by changing phase sequence of the output.

P2.30 Carrier frequency adjustment	Setting range:2.0~12.0KHz
------------------------------------	---------------------------

Carrier wave frequency can be continuously adjusted within 2.0~12.0KHz.

This function is mainly used to improve system performance, and reduce noise and vibration. Since SY8600 series adopts IGBT as power devices, carrier frequency can be higher. Increasing carrier frequency can bring following benefits: better current waveform, lower noise, which is especially suitable for applications that need low noise. However, with the increase of carrier frequency, it also brings some disadvantages, such as increase of power loss on switching devices, overheat, low efficiency, etc. Since high frequency carrier produces severe radio interference, please install filter for application with high requirement on EMI. At the same time, capacitive leakage current increases, and the wrong action of leakage protector and over current may happen.

Decreasing carrier frequency, the contrary is the case. Motor noise will increase in lower carrier frequency. Influence of carrier frequency is different for various motors. Therefore, optimal carrier frequency should be selected according to practical situation. In fact, with the increase of motor capacity, carrier frequency should decrease. For motor capacity above 37 kW, 2KHz carrier frequency is recommended.

P2.31 Zero frequency threshold	Setting range: 0~400.0Hz
P2.32 Zero frequency hysteresis	Setting range: 0~400.0Hz

The above two parameters are to set zero frequency hysteresis control.

Take analog input AI1 for example, see Fig.6-10:

Startup process:

When the Run command is issued, only after AI1 voltage arrives or exceeds VS-b, does the drive start and accelerate to the preset frequency in defined Acc time.

Stop process:

During Dec process, when AI1 voltage reduces to VS-b, the drive will not stop until it reaches VS-a and the corresponding frequency becomes fa, where fa is the threshold of zero frequency defined by P2.31, and fb, fa is defined by P2.32.

This function can realize dormancy to save energy, in this way, frequent start and stop at threshold frequency can be avoided.

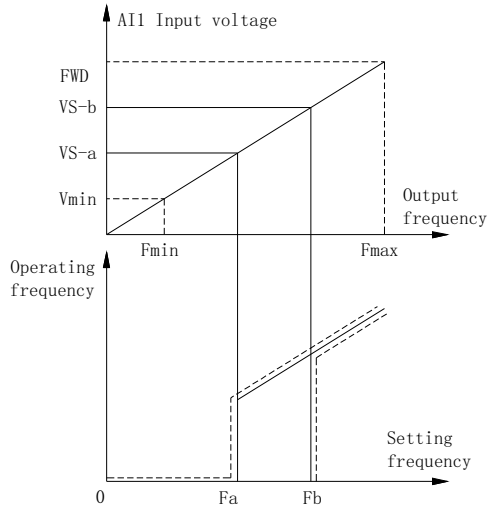

fa: Zero frequency threshold
 fb: fa + Zero frequency hysteresis
 Fig. 6-10 Zero Frequency Hysteresis

P2.33 Droop control	Setting range: 0.00~10.00Hz
---------------------	-----------------------------

When several inverter drives one load, the load of individual inverter is different due to speed difference. The inverter with higher speed drives more load. This parameter can decrease the speed when the load is increased and equalizes the load of inverters.

P3 Motor parameters

P3.00 Motor rated power	Setting range:0.4~999.9kW
P3.01 Motor rated voltage	Setting range:0~440V
P3.02 Motor rated current	Setting range:0.1~999.9A
P3.03 Motor rated frequency	Setting range:1.00~400.0Hz
P3.04 Motor rated speed	Setting range: 1~999 rpm

Note:

- In order to ensure motor tuning, please set nameplate parameter of the motor correctly.
- In order to ensure high control performance, the motor capacity should match that of the drive. Generally the motor’s power is allowed to be one grade higher or lower that of the drive.

Note:Before tuning, the parameters on the nameplate of the motor must be input correctly

P3.05 Motor auto-tuning	Setting range: 0, 1,2
-------------------------	-----------------------

Note:Before tuning, the parameters on the nameplate of the motor must be input correctly (F3.00~F3.04).

0: No operation



1: static auto tuning

If the load can not be unconnected from motor, user can adopt static auto tuning. First set F3.05 to 1, after confirmation, then press the RUN key on the Keypad, inverter will perform static auto-tuning functions.

2: overall auto- tuning

First set F3.05 to 2, after confirmation, then press the RUN key on the Keypad, inverter will perform overall auto-tuning functions. The overall auto- tuning includes static auto tuning and spinning auto tuning and the load must be unconnected form the motor.

Note:

- a. If over-current or over-voltage fault occurs during tuning process, user can adjust Add/Dec time (P0.16, P0.17) and torque boost (P4.07);
- b. Do not start tuning with load on motor;
- c. Make sure the motor is in stopping status before tuning, otherwise, the tuning can not be performed normally;
- d. Motor auto-tuning can only be performed in keypad control mode (P0.01=0).

P3.06 Stator resistance	Setting range: 0.001-20.00%
P3.07 Rotor resistance	Setting range: 0.001-20.00%
P3.08 Self inductance	Setting range: 1.000~9.999
P3.09 leakage inductance	Setting range: 0.001~1.000
P3.11 Exciting current with no load	Setting range: 0.0~999.9A

Factory settings of P3.06~F3.10 are the parameters of motor that rated power matches the inverter. If user already knows the motor's parameters, just input the motor parameters directly. However, after successfully performing motor auto-tuning, value of P3.06~P3.10 will be updated automatically.

Resistance and inductance are the relative value of the nomial motor parameters.

Resistance value=(real Resistance value) * (1.732*I) /V*100%;

Inductance value=(real Inductance value) *2*3.14*P*(1.732*I)/V;

In above formular, V is motor rated voltage defined by P3.01 ; I is motor rated current defined by P3.02 ; P is the motor rated frequency defined by P3.03.

These parameters are reference parameters for vector control, which will affect control performance directly.

P3.11 Reservation	
-------------------	--

P4 Dedicatd function for V/F control

P4.00 V/F curve control mode	Setting range: 0~4
------------------------------	--------------------

0: linear voltage/frequency mode (constant torque load), shown as curve 0 in Fig. 6-11;

1: Square voltage/frequency mode, shown as curve 1 in Fig. 6-11;

2: 0.5 times torque/frequency mode, shown as curve 2 in Fig. 6-11;

3: 1.2 times torque/frequency mode, shown as curve 3 in Fig. 6-11;



4: User defined V/F curve.

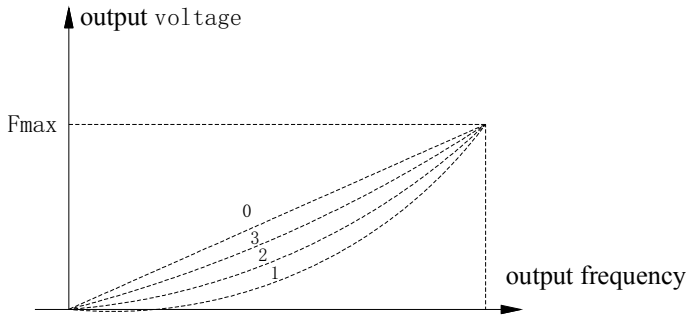

Fig. 6-11 V/F curve

P4.01 Base voltage	Setting range: 0~440V
P4.02 Base frequency	Setting range: 10.00~ 400.0Hz

Basic V/F characteristic of SY8600 series is shown in Fig. 6-12. Base Frequency F_{BASE} is the output frequency corresponding to the rated output voltage U_N . Its range is 10 to 400Hz. Generally, F_{BASE} should be selected according to rated frequency of the motor. In some special case, it can be selected according to requirement. In this condition, both motor V/F characteristic and output torque should be considered.

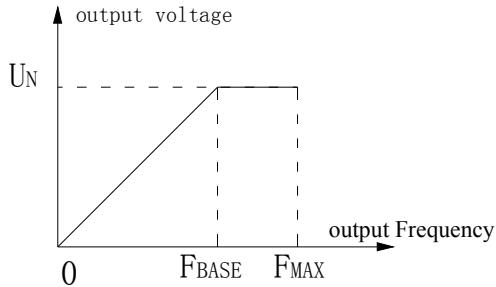

Fig. 6-12 Base voltage and frequency

P4.03 Intermediate voltage 1	Setting range:0~P4.04
P4.04 Intermediate voltage 2	Setting range:P4.03~100% (Inverter's rated voltage)
P4.05 Intermediate frequency 1	Setting range:0~P4.06
P4.06 Intermediate frequency 2	Setting range: P4.05~400.0Hz
P4.07 Torque boost	Setting range:0~20%(Inverter's rated voltage)

In order to compensate the torque drop at low frequency, the inverter can boost the output voltage in the low frequency zone, which is shown in Fig. 6-13.

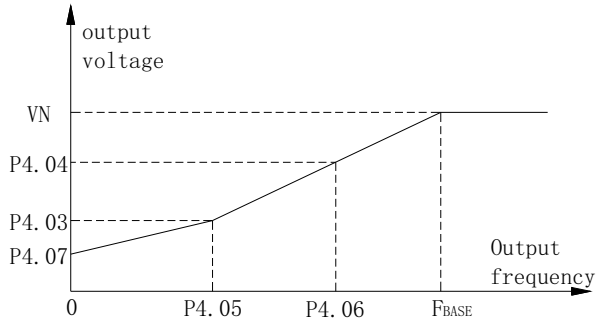

Fig. 6-13 Torque boost

Note:

Generally, factory setting (2%) can satisfy most applications. If over-current fault occurs during startup, please increase this parameter from zero gradually until it meets requirement. Pay attention that large torque boost could damage equipment.

P4.08 Slip compensation	Setting range: 0.0~10%(Rated speed P3.04)
-------------------------	---

In V/F control mode, motor's speed will be decreased with load rising. In order to ensure the motor's speed be close to synchronous speed in rated load condition, slip compensation can be done according to the preset frequency.

P4.09 AVR function	Setting range: 0, 1
--------------------	---------------------

0: Disabled; 1: Enabled

AVR is auto voltage regulation. When the inverter's input voltage differs with the rated input voltage, the inverter's output voltage can be stabilized by adjusting the width of PWM wave.

This function is disabled when the output voltage is higher than input voltage.

P5 Vector control funtion

P5.00 ASR proportional gain 1	Setting range:0.00~10.00
P5.01 ASR integration time 1	Setting range:0.00~10.00
P5.02 ASR proportional gain 2	Setting range:0.00~10.00
P5.03 ASR integration time 2	Setting range:0.00~10.00
P5.04 ASR switching frequency	Setting range:0.0~99.99Hz

Through P5.00~P5.04, user can set the proportional gain P and integration time I of speed regulator, so as to change the speed response characteristic.

- a. Speed regulator (ASR)'s structure is shown in Fig.6-14, where K_p is proportional gain P, and K_i is integration time I.

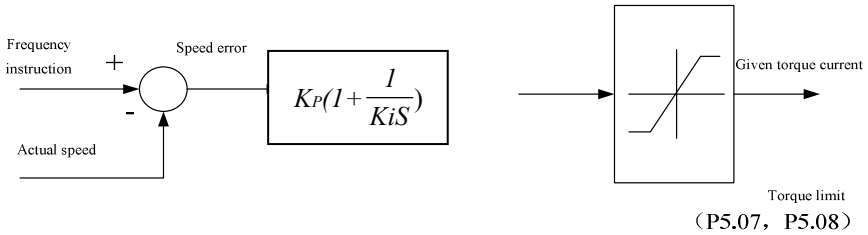

Fig. 6-14 Simplified block diagram of ASR

If the integral time is set to 0 (P5.01=0, P5.03=0), which means integral function is disabled, and the speed loop is simply a proportion regulator.

- a. Adjustment of proportion gain P and integration time I for speed regulator

Increasing P will fasten system transient response, but system oscillation may occur given too big P. Decreasing I will fasten transient response, but system oscillation and overshoot may occur given too small.

Normally, user may tune P first, increase its value as long as no system oscillation occurs; then adjust I, ensuring fast response without overshoot. Figure 6-15 shows better speed step response if P, I are set properly. Speed response can be monitored through analog terminals AO1 and AO2. Refer to P8 parameter group for detail information.

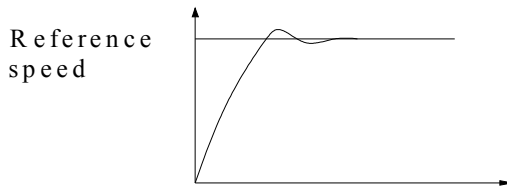

Fig. 6-15 Step response with better dynamic performance

Note:

- a. With improper PI parameters, after accelerating to high speed, over-voltage during Dec process may occur (Without external braking resistor or unit), which is caused by regenerative braking after speed overshoot. To avoid this fault, user can tune PI parameters.

- b. Adjustment of PI parameter in high/low speed applications

If system is required to respond quickly both in low and high frequency operation with load, user may set ASR switching frequency (P5.04). Normally, when the system runs at low frequency, the transient response performance can be improved by increasing P and decreasing I. Adjust ASR parameters following the procedures below:

1. Set appropriate switching frequency P5.04;
2. Tune proportional gain P5.00 and integration time P5.01 for low-speed application, and ensure no oscillation and good response performance at low frequency.
3. Next, tune proportional gain P5.02 and integration time P5.03 for high-speed application, and ensure no oscillation and good response performance at high frequency.

P5.05 Slip compensation gain	Setting range:50.0~200.0%
------------------------------	---------------------------

P5.05 is used to calculate slip frequency. Setting value 100% means rated slip frequency corresponds to rated torque current. User may decrease/increase the settings of P5.05 to adjust the speed control's difference accurately.

Note:

This function is valid to open loop vector control mode. For close loop vector control mode, F5.05 can be set to 100% for most applications.

P5.06 Torque control	Setting range:0, 1
----------------------	--------------------

This function is reserved.

P5.07 Driving torque limit	Setting range:0.0~200.0% (motor's rated current)
P5.08 Braking torque limit	Setting range:0.0~200.0%(motor's rated current)

Torque limiting is used to limit output torque current of speed regulator'.

Torque limit is the percentage of the motor's rated current; If the torque limit is 100%, then the torque current limit is the motor's rated current. P5.07 and P5.08 limit the output torque in driving state and braking state respectively, which is shown in Figure 6-16.

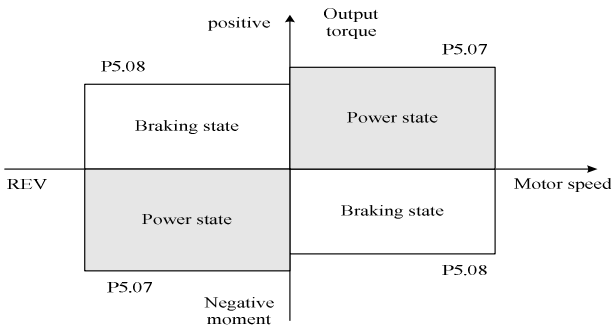

Fig. 6-16 Torque limit function

P5.09 Retain	
P5.10 Retain	

P6 I/O I/O output terminal

P6.00 FWD/REV running	Setting range: 0~3
-----------------------	--------------------

0: Two-line operation mode 1

FWD	REV	Running command
0	0	Stop
0	1	FWD
1	0	REV
1	1	Stop

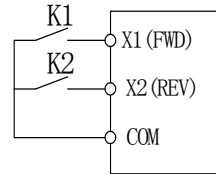

Fig. 6-17 Two-line control mode 1

In Fig. 6-17, terminal X1 is defined as running FWD, and X2 is defined as running REV.

1: Two-line operation mode 2

FWD	REV	Running command
0	0	Stop
0	1	Stop
1	0	FWD
1	1	REV

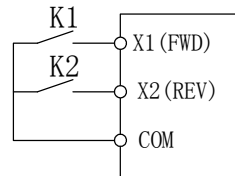

Fig.6-18 Two-line control mode 2

In Fig. 8-18, terminal X1 is defined as running FWD, and X2 is defined as running REV.

2: Three-wire operation mode 1

K	Running command

0	FWD
1	REV

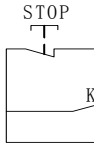

i=3, 4, 5, 6,

Fig. 6-19 Three-wire operation mode 1

3: Three-wire operation mode

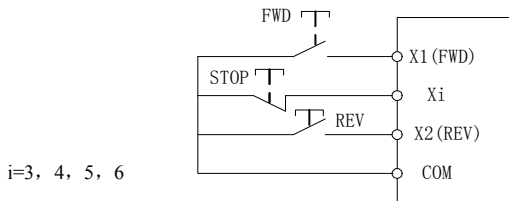

Fig. 6-20 Three-wire operation mode 2

In Fig.6-19 and 8-20, X1 is defined as running FWD, X2 is defined as running REV, and K is used for selecting running direction;

In Fig. 6-19 and 8-20, STOP is a normally closed button for stopping the motor. RUN, FWD and REV are normally open buttons for running the motor, and they are active at pulse edge.

In Fig. 6-19 and 8-20, Xi (I=3~7) is defined as three-wire running control terminal of X3~X7.

In 3-wire mode, when X3~X7 is not selected, the inverter will report ERR4 fault.

P6.01 Up/down rate	Setting range:0.10~99.99Hz/s
--------------------	------------------------------

Up/down rate: To define the increase/decrease rate when using up/down terminal to change reference frequency.

P6.02 Selecting the function of control terminal X1	Setting range: 0~30
P6.03 Selecting the function of control terminal X2	Setting range:0~30

P6.04 Selecting the function of control terminal X3	Setting range:0~30
P6.05 Selecting the function of control terminal X4	Setting range:0~30
P6.06 Selecting the function of control terminal X5	Setting range:0~30
P6.07 Selecting the function of control terminal X6	Setting range:0~30
P6.08 Selecting the function of control terminal X7	Setting range:0~30

Control terminals X1~X7 are programmable digital input terminals. X1~X7 can be defined by setting the values of P6.02~P6.08 respectively.

Programmable digital input terminal can be selected as “no function” repeatedly (that is, it can be set as 0 at the same time). Function description is shown below:

Content	Function	Content	Function
0	X1~X6: No function (can be selected repeatedly) X7: high speed pulse input	16	Free run to stop
1	Run FWD	17	Three-wire control
2	Run Rev	18	Voltage/current switching
3	External reset	19	Input terminal for recording program operation
4	Jog FWD (JOGF)	20	Start traverse operation
5	Jog REV (JOGR)	21	DC braking command
6	Multi-frequency 1	22	Acc/Dec disabled command
7	Multi-frequency 2	23	Switch between panel control mode and external terminal control mode
8	Multi-frequency 3	24	Counter trig signal
9	Multi-frequency 4	25	Counter reset signal
10	Terminals for selecting	26	PID dormancy waking up

	Acc/Dec time 1		
11	Terminals for selecting Acc/Dec time 2	27	Counter reset signal
12	Normally open terminal for inputting external fault	28	PID dormancy waking up
13	Normally close terminal for inputting external fault	29	switch between PID positive mode and negative mode
14	Frequency increase command	30	Emergence stop
15	Frequency decrease command		

Note:

- 1 0: When X1~X6=0, no function is defined.
- 2 1~2: input terminals for external operation control
In terminal control mode (P0.01=1), the terminal is used to select FWD/REV operation.
- 3 3: External RESET
If fault alarm occurs, user can reset the inverter by external terminal. This function is active at rising edge of pulse signal. It has the same function as STOP/RESET key.
- 4 4~5: Terminal for external FWD/REV Jog running control.
In terminal control mode (P0.01=1), this terminal is used to select Jog operation.
- 5 6~9: Multi-frequency terminals
In multi-frequency operation mode, 4 digital input terminals should be defined as the control terminals. Through the combination of ON/OFF state of the 4 terminals, up to 15 values can be defined set as preset frequency. Refer to parameter P2.09~P2.23 for details.
- 6 10~11: Acc/Dec time terminals

By combination of the ON/OFF state of Acc/Dec time terminals, user can select Acc/ Dec time 1~4, refer to parameter P0.16,P0.17 and P2.00~P2.05 for more details. If this function is not defined, Acc/Dec time 1 will be the default setting except in simple PLC operation mode.

7 12~13: Normally open terminal for external fault

Fault signal of external equipment can be input via the terminal, which is convenient for the drive to monitor the fault of external equipment. Once the drive receives the fault signal, it will display “Er11”. During normal stop process, this function is disabled. The fault signal has two input modes, i.e. normally open and normally close.

8. 14~15: Frequency increase/decrease command

The running frequency can be set through external terminals, thus the running frequency can be set remotely. At this time, P0.03 can be set to 2 or 3. When the terminal is ON, the frequency setting value is increased or decreased at the rate defined by P6.01; when the terminal is OFF, frequency setting value keeps constant. When these two terminals are ON at the same time, frequency setting value also keeps constant. Please refer to P0.03 parameters description.

9. 16: Free run to stop terminal (FRS)

When the function terminal is ON, inverter stops output immediately and enter stopping state, the motor enters free run to stop state.

10 17: Three-wire control

If F6.00=2 or 3, this terminal is defined as three-wire control terminal when three-wire control mode is selected. If F6.00=2 or 3, and none of X1~X7 is defined as three-wire control terminal, the inverter will report parameter setting fault ERR4. In this case, user should define “three-wire control terminal” first, and then define “three-wire control mode” (P6.00=2 or 3).

11. 18: Switching input signal

If analog setting mode is selected, (P0.09=4 5 or 6), this function is used to switch reference channel.

If this terminal is OFF, reference signal is decided by settings of panel potentiometer (P0.09=4 5 OR 6)

If this terminal is ON, reference signal is decided by settings of VS2.

12. 20: Start traverse operation

If the traverse operation is set to manual start, then traverse function is enabled if this function is selected. Refer to Pb parameter group for details.

13. 22: DC braking command

When the inverter is in Dec-to-stop process, and the running frequency is lower than initial frequency of DC injection braking defined in P1.06, this function is enabled. When the terminal is ON, DC injection braking is performed under braking voltage defined in P1.08. DC injection braking is ended only when the terminal is OFF.

When this function is enabled, parameters of DC injection braking time are invalid.

14. 23: Acc/Dec disabled command

When the terminal is ON, the inverter temporarily inhibits executing the Acc/Dec command and runs at current frequency. When the terminal is OFF, normal Acc/Dec commands can be executed. If there is any control signal with higher priority input such as external fault signal, the inverter will exit Acc/Dec inhibit state immediately and execute specified processing procedures.

15. 24: Switch between panel control mode and external terminal control mode

This function is used for selecting the physics channel that inputs inverter's running control command: Selecting between keypad and external terminal to input control commands.

Commands input via external terminals include FWD, REV, JOGF, JOGR, RUN and STOP.

This function is used in conjunction with ON/OFF state and the setting value of P0.01.

The control logic is shown in the Table below.

F0.01	Terminal state	Source of control command
0	ON	External terminals
0	OFF	Keypad
1	ON	Keypad
1	OFF	External terminals

This function is enabled during running state. User should pay attention to the drive's running status after switching.

If the drive is in keypad control mode first, connect the terminal (ON), there are 2 cases: if running command from external terminal is valid, such as FWD terminal is ON in two-wire control mode, then the drive's operation state will not change; if running command from external terminal is invalid, the drive will stop running.

16. 25: Switch between panel control mode and external terminal control mode

This function is used for selecting the physics channel that inputs inverter's running control command: Selecting between keypad and external terminal to input control commands.

Commands input via external terminals include FWD, REV, JOGF, JOGR, RUN and STOP.

This function is used in conjunction with ON/OFF state and the setting value of P0.01.

The control logic is shown in the Table below.

P0.01	Terminal state	Source of control command
0	ON	External terminals
0	OFF	Keypad
1	ON	Keypad
1	OFF	External terminals

17 26: Counter trig signal

It is the input terminal of the drive's internal counter. If the input signal of the terminal changes from ON to OFF, the counting value is increased by 1.

18. 27: Counter reset signal

This terminal is used to clear the inverter's internal counter, and is used in conjunction with Function 24 "Counter trig signal".

When the terminal is ON, internal counter is cleared to 0.

19. 28: PID dormancy waking up

- i. When PA.17=2 and this terminal is ON, PID control will exit dormancy state and execute normal PID function.

20. 29: switch between PID positive mode and negative mode:

When PA.00 is set to 0, PID positive mode is selected with the terminal is off ; negative mode is selected with the terminal is on.

21. 30: "Emergence stop"

If the terminal defined with the function is on, the inverter is in emergence stop status (motor free stop)

P6.09	Programmable relay 1	Setting range: 0~20
P6.10	Output terminal Y1 definition	Setting range: 0~20

Function selection of programmable relay output terminals and open collector output terminals is shown in the table below.

Content	Function	Content	Function
0	Programmable relay 1: No operation Output terminal Y1: No operation	11	Over voltage stall
1	Drive ready	12	External stopping command
2	Drive running signal1	13	Preset counting value arriving
3	Drive running signal2	14	Specified counting value

			arriving
4	Frequency arriving signal	15	Low voltage lockup signal
5	Frequency detection threshold 1	16	Overload pre-alarm
6	Frequency detection threshold 2	17	Drive failure signal
7	High limit frequency arriving	18	Zero speed running
8	Low limit frequency arriving	19	程序运行阶段完成
9	Overload signal	20	PG cable broken
10	Over current stall		

Functions in the table above are described as following:

- 0 0: No function is defined by programmable relay output terminal 1, and open collector output terminal Y1. is defined as frequency signal output.
- 1 1: Drive ready
The drive is in normal waiting state, and terminals output indication signal.
- 2 2: Drive running signa 1
The drive is in running state, and the terminal outputs indication signal.
- 3 3: Drive running signa2
In run status, when the drive's output frequency is 0Hz, the terminal does not output indication signal; when the drive's output frequency is above 0Hz, the terminal does output indication signal
- 4 4: Frequency arriving signal
When the drive's output frequency arrives preset frequency, the terminal outputs indication signal.
It is used in conjunction with parameter P6.11.
- 5 4~5: Frequency detection threshold 1 and 2
When the drive's output frequency arrives specified value, the terminal outputs indication signal, which is used in conjunction with parameters P6.12~P6.15.

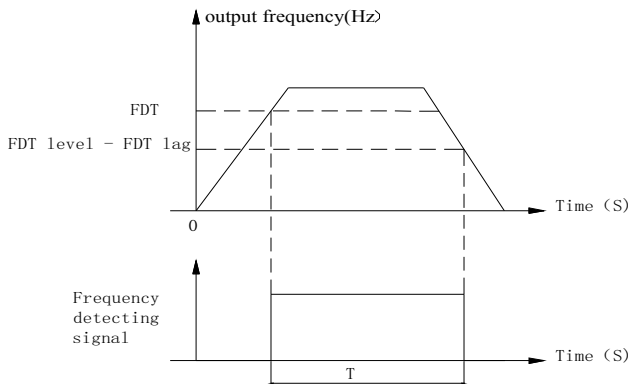

Fig. 6-21 Frequency detection threshold 1 and 2

6 7: High limit frequency arriving

When the drive's output frequency reaches high limit frequency, the terminal outputs indication signal.

7 8: Low limit frequency arriving

When the drive's output frequency reaches low limit frequency, the terminal outputs indication signal.

8 9: Overload signal

When overload occurs, the terminal outputs indication signal.

9 10: Over current stall

When over current stall occurs in running state, terminal outputs indication signal.

10 11: Over voltage stall

When over voltage stall occurs in running state, the terminal outputs indication signal.

11 12: External stopping command

During running process, when external fault signal is received by the digital input terminals, the drive reports ER11 fault, and the terminal outputs indication signal at the same time.



12 13: Preset counting value arriving

Set up counting value of the drive's internal counter. The drive inputs counting pulses via external terminals X_i ($i=1\sim7$), and the drive's internal counter counts this signal. When the preset value arrives, Y_i outputs an indication signal. When the next external counting pulse signal arrives, Y_i 's output signal recovers, and the counter restarts to count again at the same time.

13 14: Specified counting value arriving

When X_i inputs external counting pulse signal and the counting value reaches specified value defined by p6.17 (See Fig. 6-22), Y_1 outputs an indication signal, Y_1 does not recover until specified value arrives.

As shown in Fig. 6-22, if P6.16=5, P6.17=3, when X_i inputs the 3th pulse, Y_1 outputs an indication signal. When X_i inputs the 5th pulse, Y_1 outputs specified value arriving signal. Y_1 will recover when the 6th pulse arrives.

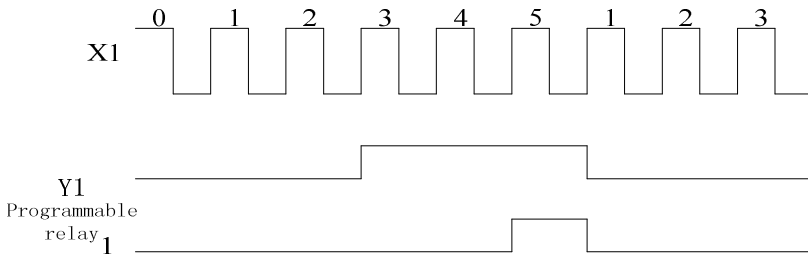

Fig. 6-22 Preset counting value arriving and specified counting value arriving

14 15: Low voltage lockup signal

When DC bus voltage is lower than the low voltage limit, the panel LED displays “LU”, and the terminal outputs indication signal at the same time.

15 16: Overload pre-alarm

According to PD.04~PD.06 overload pre-alarm setup, when the output current is higher than the setting value, the terminal outputs indication signal.

16 17: Drive failure signal

When fault occurs, the terminal outputs indication signal

17 18: Zero speed running

When the drive's running frequency is zero, the terminal outputs indication signal.

For example, in the following three conditions the terminals output indication signal:

- FWD/REV dead time running period;
- The phase when the setup frequency is lower than the start frequency when the inverter starts from zero frequency;
- In Dec process output frequency is lower than initial frequency of DC injection braking.

18 19: End signal of stage of program operation

In program operation mode, when a stage is finished, the inverter outputs a pulse with width of 250ms.

19 20: End signal of stage of program operation

In program operation mode, when a cycle is finished, the inverter outputs a pulse with width of 250ms.

P6.11 Frequency arriving width (FAR)	Setting range: 0.0~10.00Hz
--------------------------------------	----------------------------

When output terminal function is selected as frequency arriving signal, this function is used to detect output frequency range. When error between output frequency and setting value is less than FAR, the terminal outputs indication signal, as shown in Fig.6-24.

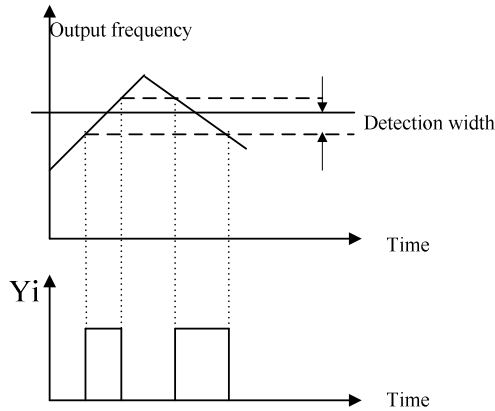

Fig.6-24 FAR and FAR detection width

P6.12 FDT1 level	Setting range: 0.0~400.0Hz
P6.13 FDT1 lag	Setting range: 0.0~10.00Hz
P6.14 FDT2 level	Setting range: 0.0~400.0Hz
P6.15 FDT2 lag	Setting range: 0.0~10.00Hz

If output frequency exceeds certain value, the terminal outputs indication signal, and this signal is called FDT level.

If output frequency decreases, the terminal continues to outputs indication signal, until the output frequency is lowered to the FDT signal width and exceeds certain width, this width is called FDT signal lag, as shown in Fig.6-21 and 6-23.

P6.16 Preset value arriving	Setting range:0~9999
P6.17 Specified value arriving	Setting range:0~9999

For P6.16 and P6.17 function, please refer to definition of terminal function 13, 14.

P6.18 Terminal logic	Setting range:0~255
----------------------	---------------------

This parameter defines positive or negative logic of terminals.

Y1	X7	X6	X5	X4	X3	X2	X1
Bit7	Bit6	Bit5	Bit4	Bit3	Bit2	Bit1	Bit0

Note:

- If bit 0 is set to 0, it means positive logic, and 1 for negative logic. Factory setting of all terminals are positive logic;
- In positive logic mode, terminal Xi is enabled if it is connected to the common terminal, and disabled if disconnected;
In negative logic mode, terminal Xi is disabled if it is connected to the common terminal, and enabled if disconnected;
In positive logic mode, terminal Yi closes when its output signal is valid;
In negative logic mode, terminal Yi opens when its output signal is valid;
- Only decimal number can be set to the drive (including display). When negative logic is selected, conversion from binary code to Hex value is shown as below:

$$\text{Setting value} = (2*Y1)^7 + (2*X6)^5 + (2*X5)^4 + (2*X4)^3 + (2*X3)^2 + (2*X2)^1 + X1$$

For example,

if X6 and X4 select negative logic and others are positive logic, then:

$$\text{Setting value} = (2*0)^6 + (2*1)^5 + (2*0)^4 + (2*1)^3 + (2*0)^2 + (2*0)^1 + 0 = 32 + 8 = 40$$

P7 Analog input terminal function

P7.00	AI1 filter time	Setting range: 0.05-5.00S
P7.01	Minimum AI1	0.0-100.0%
P7.02	Frequency corresponding to P7.06	0.00 ~ Maximum frequency
P7.03	Maximum AI1	0.0-100.0%
P7.04	Frequency corresponding to P7.08	0.00 ~ Maximum frequency

P7.05	AI2 filter time	Setting range: 0.05-5.00s
P7.06	Minimum AI2	0.0-100.0%

P7.07	Frequency corresponding to P7.06	0.00 ~ Maximum frequency
P7.08	Maximum AI2	0.0-100.0%
P7.09	Frequency corresponding to P7.09	0.00 ~ Maximum frequency

Reference signal from external input (AI1, AI2) is filtered and amplified, and then its relationship with frequency setting is shown as curve 1 in Fig. 6-25 or curve 2 in Fig.6-26.

AI2 can input current signal (4~20mA), P7.06 should be set to 20% except that S1 (AI2) is in “I” position,

P7.10	FWD/REV dead time range	Setting range: 0~10% Maximum input signal
-------	-------------------------	---

If polarity control is selected (P0.06= 2 or 3), FWD/REV dead time is set by this parameter. Refer to parameter P0.06 and fig 6-1 for details.

P7.11	AI1 filter time	Setting range: 0.05-5.00S
P7.12	Minimum AI1	0.0-100.0%
P7.13	Frequency corresponding to P7.12	0.00 ~ Maximum frequency
P7.14	Maximum AI1	0.0-100.0%
P7.15	Frequency corresponding to P7.13	0.00 ~ Maximum frequency

Reference signal(AI1) from keypad potentiometer is filtered and amplified, and then its relationship with frequency setting is shown as curve 1 in Fig. 6-25 or curve 2 in Fig. 6-26.

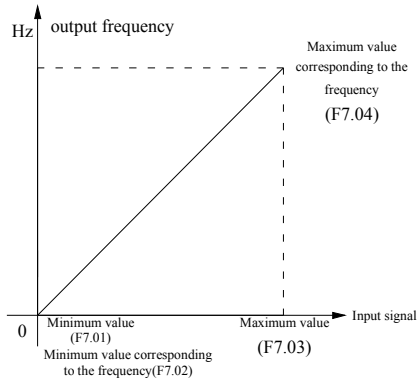

Fig. 6-25 curve 1: relationship between reference and frequency setting

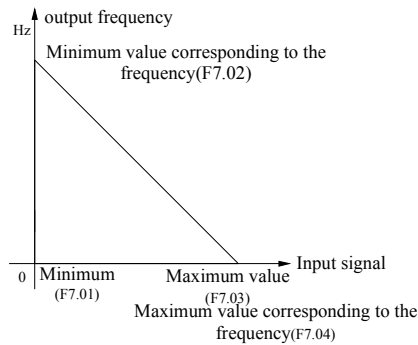

Fig. 6-26 curve 2: relationship between reference and frequency setting

P8 Analog output terminal

P8.00	AO1 output selection	Setting range:0~9
P8.01	AO2 output selection	Setting range:0~9

Inverter's state represented by analog output signal is defined by the function

codes P8.00 and P8.01, as shown below.

P8.00/P8.01	Drive state	Description
0	Running frequency/speed	0~ highest running frequency/speed
1	Frequency setting/speed	0~ highest running frequency/speed
2	Output current	0~ 2× rated current
3	Output voltage	0~+200% rated voltage
4	Output torque	-200%~+200% rated torque current
5	PI reference	0~10V
6	PI feedback	0~10V
7	Bus voltage	0-800V
8	Analog input AI1	0-10V
9	Analog input AI2	0-10V

p8.02 Minimum AO1	Setting range:0.00~100.0%
p8.03 Minimum value corresponding to F8.02	Setting range:0.00~100.0%
p8.04 Maximum AO1	Setting range:0.00~100.0%
p8.05 Maximum value corresponding to F8.04	Setting range:0.00~100.0%

This function code is used to setup maximum/minimum value of analog output signal (0~10V), and the relationship between these values and P8.00 is shown in Fig. 6-27 and 6-28.

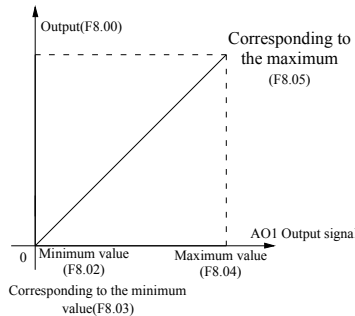

Fig. 6-27 Relationship between maximum/minimum AO1 and F8.00

For example, connect AO1 with a voltage meter (range: 0~5V) to indicate operating frequency, and the range of operating frequency is 0~50Hz (Maximum frequency=50Hz), then F8.00=0(=frequency), F8.02=0(=0V), F8.03=0(0Hz), F8.04=50%(=5V), F8.05=100%(=50Hz).

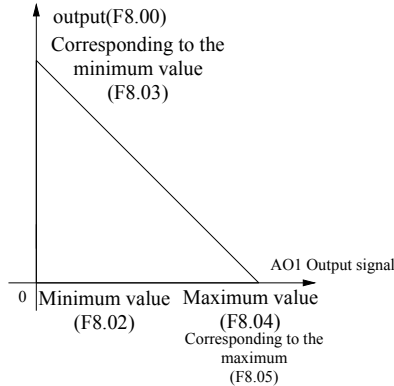

Fig. 6-28 Relationship between maximum/minimum AO1 and F8.00

P8.06	Minimum AO2	Setting range:0.00~ 100.0%
P8.07	Minimum value corresponding to F8.06	Setting range:0.00~ 100.0%
P8.08	Maximum AO2	Setting range:0.00~ 100.0%
P8.09	Maximum value corresponding to F8.08	Setting range:0.00~ 100.0%

For more information about P8.02~P8.05, refer to Fig. 6-27 and 6-28. AO2 can output voltage or current signal. To output 4~20mA signal, P8.06 should be set to 20% except that S2(AO2) is in “I” position.

P9 Program operating parameters

P9 parameter group is function code of programming operation.

Both programming operation and multi-frequency operation are used for realizing the inverter's variable speed running according to certain regulations.

One cycle of programming operation is shown in Fig. 6-29, $f_1 \sim f_7$ and $T_1 \sim T_7$ will be defined in the following function codes.

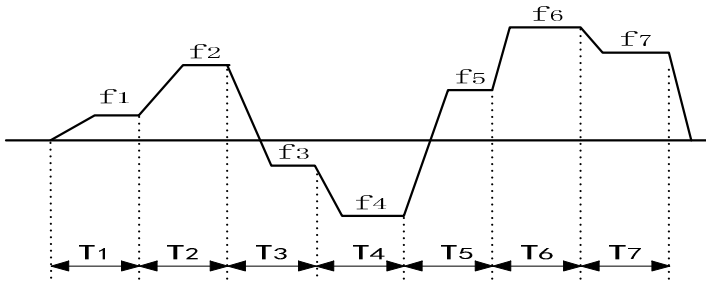

Fig. 6-29 Programming operation

P9.00 Programming operation function	Setting range:0, 1,2
--------------------------------------	----------------------

- 0: Single cycle (Stop after a single cycle)
- 1: Continuous cycle (Continue cycle operation according to setup phase parameters)
- 2: Maintain the final value (maintain the non-zero operating frequency of last stage after completing one cycle)

P9.01 Programming operation time setting unit	Setting range:0, 1
---	--------------------

- 0: second
- 1: minute

P9.02 Stage timing T1	Setting range: 0.0~3600.0
P9.03 Stage timing T2	Setting range: 0.0~3600.0
P9.04 Stage timing T3	Setting range: 0.0~3600.0
P9.05 Stage timing T4	Setting range: 0.0~3600.0
P9.06 Stage timing T5	Setting range: 0.0~3600.0
P9.07 Stage timing T6	Setting range: 0.0~3600.0
P9.08 Stage timing T7	Setting range: 0.0~3600.0
P9.09 Stage timing T8	Setting range: 0.0~3600.0

P9.10 Stage timingT9	Setting range: 0.0~3600.0
P9.11 Stage timingT10	Setting range: 0.0~3600.0
P9.12 Stage timingT11	Setting range: 0.0~3600.0
P9.13 Stage timingT12	Setting range: 0.0~3600.0
P9.14 Stage timingT13	Setting range: 0.0~3600.0
P9.15 Stage timingT14	Setting range: 0.0~3600.0
P9.16 Stage timingT15	Setting range: 0.0~3600.0

Parameters P9.02~P9.16 are used to set running time of each stage.

P9.17 T1Running mode	Setting range: 0~7
P9.18 T2Running mode	Setting range: 0~7
P9.19 T3Running mode	Setting range: 0~7
P9.20 T4Running mode	Setting range: 0~7
P9.21 T5Running mode	Setting range: 0~7
P9.22 T6Running mode	Setting range: 0~7
P9.23 T7Running mode	Setting range: 0~7
P9.24 T8Running mode	Setting range: 0~7
P9.25 T9Running mode	Setting range: 0~7
P9.26 T10Running mode	Setting range: 0~7
P9.27 T11Running mode	Setting range: 0~7
P9.28 T12Running mode	Setting range: 0~7
P9.29 T13Running mode	Setting range: 0~7
P9.30 T14Running mode	Setting range: 0~7
P9.31 T15Running mode	Setting range: 0~7

P9.17~P9.31 are used to set operating direction and Acc time of each stage:

0 : Run forward Acc/Dec time is 1; 1: Run forward Acc/Dec time is 2; 2 : Run forward Acc/Dec time is 3; 3: Run forward Acc/Dec time is 4; 4 : Run reverse Acc/Dec time is 1; 5 : Run reverse Acc/Dec time is 2; 6 : Run reverse Acc/Dec time is 3; 7 : Run reverse Acc/Dec time is 4;

P9.32 Record function	Setting range:0~2
-----------------------	-------------------

0: Record function disabled

In programming operation state, if user press stop key, counter value of present program will not be recorded. Input running command again, program will run from the first stage.

1: Record function enabled

In programming operation state, program will pause when stop key is pressed. Input running command again, program will run from the breakpoint.

When the drive stops, user can clear counter value of current program by setting function code P9.00 again.

2: Record function enabled ,

In programming operation state, program will pause when stop key is pressed. Input running command again, program will run from the breakpoint,

When the drive stops, user can clear counter value of current program by setting function code P9.00 again.

PA PID parameter

FA parameter group defines parameters of PID control function.

PID control function diagram is shown below, where P is proportional gain, I is integration time, D is differential time.

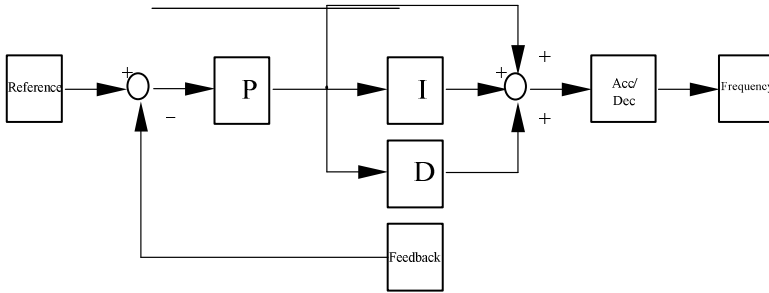

PA.00 PID control characteristic	Setting range: 0、1
----------------------------------	--------------------

0: Positive characteristic

The Motor speed is required to increases with the reference speed.

1: Negative characteristic

The motor speed is required to decrease when the reference value increases.

PA.01 Reference selection	Setting range: 0、1、2、3
---------------------------	------------------------

0: Panel Digital setting

1: External analog signal AI1

2: External analog signal AI2

3: Rs-485 communication setting

4: Panel potentiometer setting (0~5V)

PA.02 Feedback channel selection	Setting range: 0、1
----------------------------------	--------------------

1: External analog signal AI1 (0~10V)

2: Analog signal AI2 (0~10V or 4~20mA)

PA.03 Digital setting of reference	Setting range: 0.00V~10.00V
------------------------------------	-----------------------------

Digital reference is set by UP/DOWN keypad.

PA.04 Minimum referenc	Setting range: 0.0~100.0%
PA.05 Maximum reference	Setting range: 0.0~150.0%
PA.06 Minimum feedback	Setting range: 0.0~100.0%
PA.07 Minimum feedback	Setting range: 0.0~150.0%

By setting parameter PA.04~PA.07, actual value of reference and feedback can

be displayed accurately.

PA.08 Proportional gain	Setting range:0.0~10.00
PA.09 Integration time Ti	Setting range:0.00(no integration)~99.99s
PA.10 Integration time Ti	Setting range:0.00(no differentiation)~99.99s
PA.11 Sample cycle T	Setting range:0.00(do not specify T)~99.99s

Setup parameters of PID regulator

PA.12 Error limit	Setting range: 0.0~15.0% ((corresponding to close loop input))
-------------------	--

Definition: relative error of close loop system = $\frac{|\text{input value} - \text{feedback value}|}{\text{input value}} \times 100\%$.

If relative error of close loop system is bigger than the setting value of error limit, then the PID regulator will adjust the error.

If relative error of close loop system is in the setting range of error limit, then stop PID regulating, PID regulator's output maintains constant.

PA.13 Level of abnormal feedback signal	Setting range: 0~100%
---	-----------------------

This function code defines abnormal level of feedback signal.

Definition: Abnormal level = $\frac{|\text{reference} - \text{feedback}|}{\text{reference}} \times 100\%$

PA.14 Detection time of abnormal feedback signal	Setting range: 0~3600S
--	------------------------

This function code defines the detection time of abnormal feedback signal. When feedback signal exceeds abnormal level and hold time exceeds the detection time, action at abnormal signal (ER.06) will be executed. When this parameter is set to 0, the abnormal feedback signal detect function is disable.

PA.15	
-------	--

PA.16 PID Sleep control	Setting range: 0~2
-------------------------	--------------------

- 0: No sleep function;
- 1: Internal waking up, which is controlled by parameters PA.17~PA.20;
- 2: External input terminal, which is controlled by terminal function 26 (PID waking terminal), is decided by parameter P6.02~P6.08.

PA.17 Delay time of sleeping	Setting range: 0.0~3600S
PA.18 Sleeping frequency	Setting range: 0.0~400.0Hz
PA.19 Delay time of waking	Setting range: 0.0~60S
PA.20 Waking value	Setting range: 0.0~100%实际值

For PID control, parameters PA.17~ PA.20 define delay time of sleeping, sleeping frequency, delay time of waking and waking value.

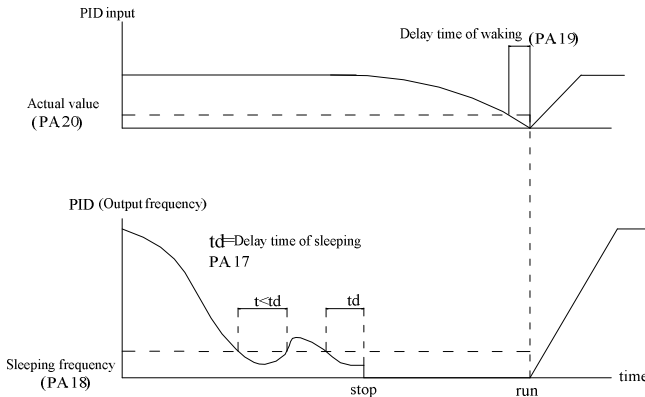

Fig. 6-30 PID sleeping and waking

Pb Traverse function

Pb.00 Traverse mode	Setting range: 0、1
---------------------	--------------------

0: Auto mode

At first, the drive operates at preset frequency of traverse operation (Pb.01) for certain time (Pb.02), and then enter traverse mode automatically.

1: Manual mode

If the multi-function terminal (Xi is set to terminal function 20) is enabled, the drive will enter traverse mode. If the terminal is disabled, the drive will exit traverse operation and operate at the preset traverse frequency (Pb.01).

Pb.01 Preset traverse frequency	Setting range: 0.00~400.0Hz
Pb.02 Hold time of preset traverse frequency	Setting range: 0.0~3600s

Pb.01 defines drive's operating frequency before entering traverse operation. In auto mode, Pb.02 defines the hold time of preset traverse frequency before traverse operation. In manual mode, Pb.02 setting is invalid. Refer to Fig. 6-31 for details.

Pb.03 Preset central frequency	Setting range: 0.00~400.0 Hz
--------------------------------	------------------------------

Traverse operation is shown in Fig. 6-31.

Pb.04 Travers amplitude	Setting range: 0.0~50%
-------------------------	------------------------

Travers amplitude = Preset central frequency×Fb.04

Pb.05 Step frequency	Setting range: 0.0~50%
----------------------	------------------------

Refer to Fig. 6-31. If it is set at 0, then there will be no step frequency.

Pb.06 Traverse cycle	Setting range: 0.1~999.9S
----------------------	---------------------------

It defines the period of traverse operation including rising and falling time.

Pb.07 Rise time of triangular wave	Setting range: 0.0~100.0%
------------------------------------	---------------------------

It defines the rising time ($Pb.06 \times Pb.07$ s) of traverse operation, and falling time ($Fb.06 \times (1 - Fb.07)$ s). Please refer to Fig. 6-31.

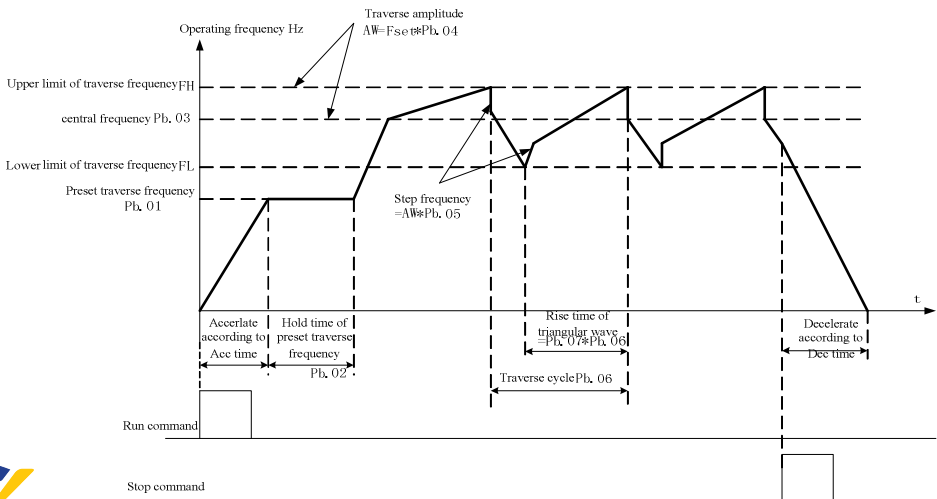

Fig. 6-31 Traverse operation

PC Communication and Bus control function

Pc.00 Baud rate selection	Setting range: 0~5
---------------------------	--------------------

Select baud rate of serial communication

0:1200BPS 1:2400 BPS 2:4800 BPS 3:9600 BPS 4:19200 BPS 5:38400 BPS

Pc.01 Data Format	Setting range: 0~8
-------------------	--------------------

Data format of serial communication protocol:

- 0: 8, N, 2 For RTU (MODBUS) (Default)
- 1: 8, E, 1 For RTU (MODBUS)
- 2: 8, 0, 1 For RTU (MODBUS)
- 3: 7, N, 2 For ASCII (MODBUS)
- 4: 7, E, 1 For ASCII (MODBUS)
- 5: 7, 0, 1 For ASCII (MODBUS)
- 6: 8,N,1 free communication format
- 7: 8,E,1 free communication format
- 8: 8,O,1 free communication format

Pc.02 Local address	Setting range: 1~32
---------------------	---------------------

When the host is communicating with several inverters, inverter's address is defined in this function code.

Pc.03 Communication timeout detect	Setting range: 0.0、0.1~100.0s
------------------------------------	-------------------------------

The setting value is 0:No communication overtime protection.

The setting value isn't 0, in RS485 communication control mode, if the communication between the inverter and the host is still abnormal in the time defined by Pc.03, ER05 fault is displayed and the inverter acts according to the setting value of Pc.05.

Pc.04 Response delay	Setting range: 0 ~1000ms
----------------------	--------------------------

Response delay refers to the time from the drive receiving and executing the command of the host to returning reply frame to the host.

Pc.05 EEROM Store function	Setting range: 0、1
----------------------------	--------------------

- 0: The parameter is stored into EEROM in communication.
- 1: The parameter is not stored into EEROM in communication.

Pd Faults and protection parameters

Pd.00 Motor overload protection mode	Setting range: 0, 1, 2
--------------------------------------	------------------------

- 0: No protection
- 1: Common motor protection
Since cooling conditions of common motor deteriorates at low speed, please lower the motor’s thermal protection threshold at this time.
- 2: Variable frequency motor protection
Since the variable frequency motor applies forced air-cooling, the protection parameters needn't be adjusted during low speed running.

Pd.01 Motor overload protection factor	Setting range: 20.0%-150.0%
--	-----------------------------

Heat dissipation becomes worse at low frequency, and high temperature will reduce service life of the motor. Through setting threshold of the electronic thermal overload relay, overload current and current limit will be proportionally adjusted.

When motor capacity is lower than that of the drive, this function is used provide overheat protection for the motor.

When several motors are driven by the same variable speed drive, this function is disabled. When display readings reaches 100%, overload protection will be triggered

Pd.02 Over voltage stall selection	Setting range: 0,1
------------------------------------	--------------------

Over voltage stall selection

- 0: Disabled; 1:Enabled

In inverter's Dec process, the actual motor speed may be higher than the output synchronized speed of the inverter due to the load inertia. At this time, the motor will feed the energy back to the inverter, resulting in the voltage rise on the inverter's DC bus. If no measures being taken, tripping will occur due to over voltage.

The overvoltage stall protection function is that during the Dec running, the inverter detects the bus voltage and compares it with the stall overvoltage point defined by

PD.03. If the bus voltage exceeds the stall overvoltage point, the inverter will stop reducing its output frequency. When the detected bus voltage is lower than the point, the Dec running will be restored, as shown in Fig.6-32.

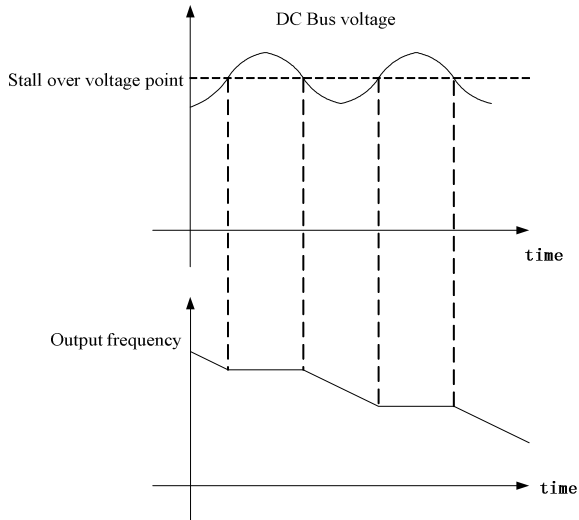

Fig. 6-32 Over voltage stall function

Pd.03 Stall over voltage point	Setting range: 120.0%~150.0%
--------------------------------	------------------------------

Stall over ovtage point = 120.0%~150.0% inverter’s rated peak voltage

Pd.04 Selection of overload pre-alarm detection	Setting range: 0, 1
---	---------------------

- 0: Overload is only monitored during constant speed operation, and alarms when overload occurs;
- 1: Overload is monitored all the time, and alarms when overload occurs;

Pd.05 Overload detection threshold	Setting range: 20-180%
------------------------------------	------------------------

Pd.06 Overload pre-alarm delay	Setting range: 0-60.0s
--------------------------------	------------------------

PD.05 defines the threshold value for overload alarm. It is a percentage of rated current.

Pd.07 Auto current limiting threshold	Setting range: 20.0~150.0% (drive’s
---------------------------------------	-------------------------------------

	rated output current)
Pd.08 Frequency decrease rate during	Setting range: 0.00-99.99Hz/S
Pd.09 Action mode of auto current limiting	Setting range: 0、1、2

Auto current limiting function is used to limit the load current under the preset current (PD.07) in real time to avoid trip due to over-current. This function is especially useful for the applications of larger load inertia or sharp change of load.

PD.07 defines the threshold for current limiting. Its setting is a percentage of drive's rated current I_e . PD.08 defines the decreasing rate of output frequency when the drive is in auto current limiting status. If PD.08 is set too small, overload fault may occur. If PD.08 is set too big, the drive may be in energy generation status for long time that may result in overvoltage protection.

The action mode of auto current limiting function is decided by PD.09:

PD.09= 0: disabled;

PD.09= 1: auto current limiting is effective during acceleration or deceleration but ineffective at constant speed;

PD.09= 2: auto current limiting is effective during acceleration/deceleration and constant speed;

Pd.10 Auto reset	Setting range: 0~5
------------------	--------------------

0: disabled; 1~5: times of fault reset;

Pd.11 Auto reset interval	Setting range: 2~20s
---------------------------	----------------------

When fault occurs, the drive stops output. After the time defined by PD.11, the drive resets fault automatically and continue running.

PD.10 defines the times of auto fault reset. If PD.10=0, auto reset function is disabled, and user can only reset fault in manual mode.

Pd.12 Relay action in Auto reset	Setting range: 0、1
----------------------------------	--------------------

This parameter determine the relay action in auto reset period of the inverter.

0: no action

1: action

Pd.13 Act selection at undervoltage fault	Setting range: 0、1、2
---	----------------------

0: When undervoltage occurs, fault relay does not act, and fault code will

not be saved.

- 1: When undervoltage occurs during running, fault relay acts and fault code will be saved. When undervoltage occurs during stop state, fault relay does not act, and fault code will not be saved.
- 2: When undervoltage occurs in running or stopping state, fault relay acts and fault code will be saved.

Pd.14 Input phase loss function	Setting range: 0~1
---------------------------------	--------------------

0: Disable

The input phase loss function is disabled.

1: Enable

The input phase loss function is enabled. (only available on three phase input above 110kw inverter)

Pd.15 Output phase loss function	Setting range: 0~1
----------------------------------	--------------------

0: Disable

The output phase loss function is disabled.

1: Enable

The output phase loss function is enabled.

Pd.16 Under voltage point	Setting range: 360~440
---------------------------	------------------------

Default value is 400v (DC voltage). In some case when the input voltage is low or not stable, the value can be adjusted to avoid under voltage fault.

PE Factory reserved

PE.00~PE.05 are reserved parameters for individual consumer.

PF Factory reserved

PF.00~PF.19 are reserved parameters for individual consumer.

PH Display function

PH.00 running display parameters selection	Setting range: 0~14
--	---------------------

SY8600 drive has 15 state parameters in running state. User can scroll through them by pressing ►► key during running process. Function code PH.00 defines the default display parameter after starting, which includes:

Frequency setting



- 1: Running frequency
- 2: Output current
- 3: Output voltage
- 4: Bus voltage
- 5: Overload rate
- 6: Preset line speed
- 7: Running line speed
- 8: Output torque
- 9: PI reference
- 10: PI feedback
- 11: Analog input AI1
- 12: Analog input AI2
- 13: I/O status(0~511)
- 14: External counting value

Inpt/output IO status correspond as blow:

relay1	Y1	X7	X6	X5	X4	X3	X2	X1
Bit8	Bit7	Bit6	Bit5	Bit4	Bit3	Bit2	Bit1	Bit0

PH.01 Display parameters at stop	Setting range: 0~8
----------------------------------	--------------------

SY8600 drive has 9 state parameters in stopping state. User can scroll through them by pressing ►► key during stop state.

Function code PH.01 defines the default display parameter upon power on, which includes:

- 0: Frequency setting
- 1: Preset line speed
- 2: DC Bus voltage
- 3: Analog input AI1
- 4: Analog input AI2
- 5: I/O status
- 6: external counting value

7: PI reference

8:PI feedback

PH.02 Line speed factor	Setting range: 0.1~100
-------------------------	------------------------

When line speed is displayed, line speed = Output frequency × Line speed factor

PH.03 Reserved	
----------------	--

PH.04 IPM heatsink temperature 1	Setting range: 0~100°C
----------------------------------	------------------------

PH.05 IPM heatsink temperature2	Setting range: 0~100°C
---------------------------------	------------------------

Display IPM heatsink temperature.

PH.06 1st fault type	Setting range:
----------------------	----------------

PH.07 2nd fault type	Setting range:
----------------------	----------------

PH.08 3rd fault type	Setting range:
----------------------	----------------

PH.06~PH.08 are used for memorizing the latest three fault types, and can record the voltage, current, frequency and terminal state at the last fault (in PH.09~PH.13) for checking.

Please refer to Chapter 7 for fault descriptions.

PH.09 Bus voltage at last fault (V)	Setting range: 0~999
-------------------------------------	----------------------

PH.10 Output current at last fault (A)	Setting range: 0~999.9
--	------------------------

PH.11 Frequency setting at last fault (Hz)	Setting range: 0~400.0
--	------------------------

PH.12 Running frequency at last fault (Hz)	Setting range: 0~400.0
--	------------------------

PH.13 I/O state at last fault	Setting range: 0~511
-------------------------------	----------------------

PH.14 Total operating time	Setting range: 0~9999
----------------------------	-----------------------

PH.15 Software version	Setting range: 0~9.99
------------------------	-----------------------

PH.16 Keyboard Software version	Setting range: 0~9.99
---------------------------------	-----------------------

PH.12At last time, I/O Status correspond as blow:

relay1	Y1	X7	X6	X5	X4	X3	X2	X1
Bit8	Bit7	Bit6	Bit5	Bit4	Bit3	Bit2	Bit1	Bit0

Chapter 7 Fault diagnosis and troubleshooting

7.1 Fault query at fault

If control power supply is normal at fault, the drive will be in fault displaying status all the times. At this time, user can enter parameter group PH to get related information about the failure, such as output frequency, frequency setting, output current, rotating direction, operating condition, and the 3 latest faults, which is shown in the table below.

Fault code	Display content	Description
PH.06	Fault code	1st fault type
PH.07		2nd fault type
PH.08		3rd fault type
PH.09	Date (With unit)	Bus voltage at last fault
PH.10		Output current at last fault
PH.11		Frequency setting at last fault
PH.12		Running frequency at last fault
PH.13		I/O terminal's state at last fault

7.2 List of Fault and Alarm Information

SY8600 serial inverter is equipped with complete protection functions to provide efficient protection while utilizing its performance sufficiently. Some failure instructions may be displayed during operation. Compare the instructions with the following table and analyze, decide the causes and solve failures. For damages on units or questions that can't be resolved, please contact with local distributors/agents, service centers or manufacturer for solutions.

Failure No	Failure code	Failure description	Potential causes	Solutions
1	oc1	Over current protection when acceleration operation	Low grid voltage	Check input power supply
			Startup too fast during motor operation	Restart after the motor stops rotating
			Rotating inertial of load is very large and shock load is very heavy	Increase the acceleration time and reduce the occurrences of sudden change of load
			Improper setting of motor parameters	Set motor parameters properly
			Set start-up frequency too high	Decrease start-up frequency

Failure No	Failure code	Failure description	Potential causes	Solutions
			Acceleration time is too short	Lengthen acceleration time
			Set V/F curve ratio too large	Adjust V/F curve setting and torque boost
			Power level of inverter is small	Replace with inverter with proper model
2	oc2	Over current protection when deceleration operation	Low grid voltage	Check input power supply
			Rotating inertial of load is too large	Choose appropriate energy braking components
			Improper setting of motor parameters	Set motor parameters properly
			Deceleration time is too short	Lengthen deceleration time
			Power level of inverter is small	Replace to inverter with proper model
3	oc3	Over current protection when operation with constant speed	Sudden change of load during operation	Decrease load's abrupt frequency change and amplitude
			Improper setting of motor parameters	Set motor parameters properly
			Power level of inverter is small	Replace to inverter with proper model
4	occ1	Igbt module protection in Acc process	Low grid voltage	Check input power supply
			Startup too fast during motor operation	Restart after the motor stops rotating
			Rotating inertial of load is very large and shock load is very heavy	Increase the acceleration time and reduce the occurrences of sudden change of load
			Improper setting of motor parameters	Set motor parameters properly
			Set start-up frequency too high	Decrease start-up frequency
			Acceleration time is too short	Lengthen acceleration time
			Set V/F curve ratio too large	Adjust V/F curve setting and torque boost
			Power level of inverter is small	Replace with inverter with proper model
5	occ2	Igbt module protection in Dec process	Low grid voltage	Check input power supply
			Rotating inertial of load is too large	Choose appropriate energy braking components
			Improper setting of motor parameters	Set motor parameters properly
			Deceleration time is too short	Lengthen deceleration time
			Power level of inverter is small	Replace to inverter with proper model
6	occ3	Igbt module protection in constant speed process	Sudden change of load during operation	Decrease load's abrupt frequency change and amplitude
			Improper setting of motor parameters	Set motor parameters properly
			Power level of inverter is small	Replace to inverter with proper model
10	ou1	Over voltage protection when acceleration operation	Motor short to ground	Check motor wiring
			Abnormal input power supply voltage	Check input power supply
			Fast start-up again when motor operates with high speed	Start again after the motor stop rotating
11	ou2	Over voltage	Motor short to ground	Check motor wiring

Failure No	Failure code	Failure description	Potential causes	Solutions
		protection when deceleration operation	Rotating inertial of load is too large	Choose appropriate energy braking components
			Deceleration time is too short	Lengthen deceleration time
12	ou3	Over voltage protection when operation with constant speed	Motor short to ground	Check motor wiring
			Abnormal input power supply	Check input power supply
15	oH2	Heatsink 2 over temperature protection	Ambient over-temperature	Lower the ambient temperature and strengthen ventilation and radiation.
			Blockage of air duct	Clean the dusts, wools and other foreign objects in the air duct.
			Fan failure	Check whether fan wirings are well connected. Replace a new fan of the same model.
			Inverter module failure	Seek for technical support
			Temperature detection circuit failure	Seek for technical support
16	LU	Power under voltage	The power voltage is lower than the minimum operating voltage of the equipment	Check input power supply
			The internal power source of the inverter is abnormal	Seek for technical support
17	oH1	Heatsink 1 over temperature protection	Ambient over-temperature	Lower the ambient temperature and strengthen ventilation and radiation.
			Blockage of air duct	Clean the dusts, wools and other foreign objects in the air duct.
			Fan failure	Check whether fan wirings are well connected. Replace a new fan of the same model.
			Inverter module failure	Seek for technical support
			Temperature detection circuit failure	Seek for technical support
18	oL1	Inverter overload protection	Input power under voltage	Check input power supply
			Fast start-up when motor operates with high speed	Start again after the motor stop rotating
			Keep overloading for a long period of time	Shorten the overloading time and reduce load
			Acceleration and deceleration time is too short	Prolong the acceleration/deceleration time
			V/F curve ratio is set too large	Adjust V/F curve setting and torque boost
			Power level of inverter is small	Replace to inverter with proper model
19	oL2	Motor overload protection	Input power under voltage	Check input power supply
			Motor rotation is blocked or load mutation occurs	Prevent the motor rotation from blocking and reduce the load mutation



Failure No	Failure code	Failure description	Potential causes	Solutions
			Common motor maintains running under heavy load for a long period of time	Replace the common motor with variable frequency motor or improve the running frequency
			Motor overload protection time is set too small	Increase the motor overload protection time
			V/F curve ratio is set too large	Adjust V/F curve setting and torque increment
			DC braking current is set too high	Reduce the DC brake current
20	LP	Input power failure	There is abnormal connection, missing connection or disconnection at the power terminal of the inverter	Check the power connections as per the operational regulations and eliminate the errors of missing connection and disconnection
21	SP	Abnormal output phase loss	There is abnormal connection, missing connection or disconnection at the output side of the inverter	Check the power connections at the output side of the inverter as per the operational regulations and eliminate the errors of missing connection and disconnection
22	ER01	EEPROM failure	EEPROM reading and writing failure	Seek for technical support
23	ER02	CPU failure	CPU failure	Seek for technical support
24	ER03	Keypad communication fault	Keypad or its control line failure;	Check the connection of Keypad and its control line.
			CPU failure	Seek for technical support
25	ER04	Parameter setting failure	In traverse or three-wire operation mode, wrong parameter setting	Modify parameter setting
26	ER05	Communication abnormal 2 (Terminal 485)	The communication of terminal 485 is disconnected	Check the connection of the equipment communications
			The baud rate is set improperly	Set compatible baud rate
			The communication of terminal 485 is faulty	Check whether the data receiving and transmission complies with the protocol, whether the check sum is correct and whether the receiving and transmission interval complies with the requirements
			The communication of terminal 485 is time-out	Check whether the communication timeout is set properly and confirm the communication cycle of the application program
			The failure alarm parameter is set improperly	Adjust the failure alarm parameter
27	ER06	Analog close loop	Improper setting of FA	Modify setting of FA parameter group;

Failure No	Failure code	Failure description	Potential causes	Solutions
		feedback failure Analog close loop feedback failure	parameter group; Feedback signal lost	. Check feedback signal.
28	ER07	Tuning error	Improper setting of motor parameters; Significant deviation of parameters obtained after tuning comparing with the standard parameters;	Re-set the motor's rated parameters; Excute mtor aut-tuning again under zero load condition.
30	ER09	Current detection failure	Current sensor failure and bad contact	Check the current sensor
32	END	Trial period is outdated	Contact your supplier	Contact your supplier
33	ER12	External fault	Act trigger by external fault	Check external device according external fault signal
34	OL	Overload pre-alarm	1. Refer to OL1 and OL2; 2. Improper setting of FE.04~FE.06	1. Refer to OL1 and OL2; 2. Modify setting of FE.04~FE.06

7.3 Troubleshooting Procedures

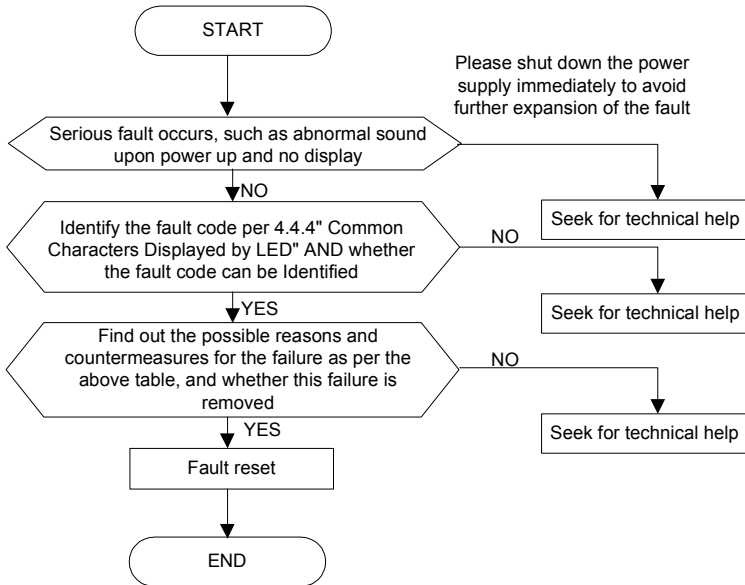

Chapter 8 Routine Repair and Maintenance

The application environment (such as temperature, humidity, dust and powder, wool, smoke and oscillation), burning and wearing of internal devices and other factors may increase the possibilities of inverter failure. To reduce the failures and prolong the service life the inverter, it needs to conduct routine repair and periodic maintenance.

 **Note**

1. Only the personnel receiving professional training can dismantle and replace the inverter components.
2. Prior to inspection and maintenance, please make sure that the power supply to the inverter has been shut down for at least ten minutes or the CHARGER indicator is OFF, or there may be risks of electric shock (the inverter with power level of TGCTGCV5-H-4T11G/15L or above has CHARGER indicator).
3. Do not leave metal components and parts in the inverter, or it may damage the equipment.

8.1 Routine Maintenance

The inverter shall be used under the allowable conditions as recommended in this manual and its routine maintenance shall be conducted as per the table below.

Item	Inspection Contents	Inspection Means	Criteria
Operating Environment	Temperature	Thermometer	-10 ~ +40°C Derated at 40 to 50°C, and the rated output current shall be decreased by 1% for every temperature rise of 1°C.
	Humidity	Humidimeter	5 ~ 95%, no condensing
	Dust, oil, water and drop	Visual check	There are no dust, oil, water and drop.
	Vibration	Special test instrument	3.5mm, 2~ 9Hz; 10m/s ² , 9~ 200Hz; 15m/s ² , 200~ 500Hz
	Gas	Special test instrument, smell check and visual check	There are no abnormal smell and smoke.
Inverter	Overheat	Special test instrument	Exhaust normal
	Sound	Listen	There is no abnormal sound.
	Gas	Smell and visual check	There are no abnormal smell and smoke.
	Physical appearance	Visual check	The physical appearance is kept intact.
	Heatsink fan ventilation	Visual check	There are no fouling and wool that block the air duct.
	Input current	Amperemeter	In the allowable operating range. Refer to the nameplate.
	Input voltage	Voltmeter	In the allowable operating range. Refer to the nameplate.
	Output current	Amperemeter	In the rated value range. It can be overloaded for a short while.
Output voltage	Voltmeter	In the rated value range.	
Motor	Overheat	Special test instrument and smell.	There are no overheat fault and burning smell.



Item	Inspection Contents	Inspection Means	Criteria
	Sound	Listen	There is no abnormal sound.
	Vibration	Special test instrument	There is no abnormal oscillation.

8.2 Periodic Maintenance

It needs to perform periodic inspection on the inverter once every three to six months according to the application environment and work conditions.

Item	Inspection Contents	Inspection Means	Criteria
Inverter	Main circuit terminal	Screwdriver/sleeve	The screws are tightened and the cables are kept well.
	PE terminal	Screwdriver/sleeve	The screws are tightened and the cables are kept well.
	Control circuit terminal	Screwdriver	The screws are tightened and the cables are kept well.
	Reliability of internal connections and connectors	Screwdriver and hands	Connection is firm and reliable.
	Expansion card connector	Screwdriver and hands	Connection is firm and reliable.
	Mounting screws	Screwdriver/sleeve	The screws are tightened.
	Cleaning the dusts and powders	Cleaner	There are no dusts and wools.
	Internal foreign objects	Visual check	There are no foreign objects.
Motor	Insulation test	500VDC megameter	Normal

8.3 Component Replacement

Different types of components have different service lives. The service lives of the components are subject to the environment and application conditions. Better working environment may prolong the service lives of the components. The cooling fan and electrolytic capacitor are vulnerable components and shall be conducted routine inspection as per the table below. If any fault occurs, please conduct immediate replacement.

Vulnerable Components	Damage Causes	Solutions	Items for Routine Inspection
Fan	Bearing wear, blade aging	Change	The fan blade has no cracks and rotates normally. The screws are tightened.
Electrolytic capacitor	Ambient temperature is relatively high and electrolyte volatilizes.	Change	There are no electrolyte leakage, color change, crack and shell inflation. The safety valve is normal. Static capacity is equal to or higher than the initial value times 0.85.

 **Note**

When the inverter is stored for a long period of time, power connection test shall be conducted once within two years and last at least five hours. It can use voltage regulator to gradually increase the value to the rated value when power connection is performed.

8.4 Insulation Test

Since the inverter has undergone insulation test upon its ex-factory, the user shall not perform such test as much as possible under general condition. If the test is unavoidable, please perform the test strictly according to the following procedures, or it may damage the inverter.

It shall perform dielectric test strictly, or it may damage the inverter. If the dielectric test is unavoidable, please contact our company.

■ Main Circuit Insulation Test

- ◆ Utilize 500VDC megameter to perform test under condition of main power shutdown;
- ◆ Disconnect all the control board circuits to prevent the control circuits from connecting with the test voltage. For the inverter with power level of SY8600-4110G/4150P and SY8600-4185G/4220P, it must disconnect the terminal J1 on the drive board and the PE. For the inverter with power level of SY8600-4185G/4220P or above, it must disconnect three pieces of cables entry to the surge absorption circuit. Pack the disconnected cable heads with insulating tapes properly;
- ◆ The main circuit terminal shall be connected with public conducting wires:
- ◆

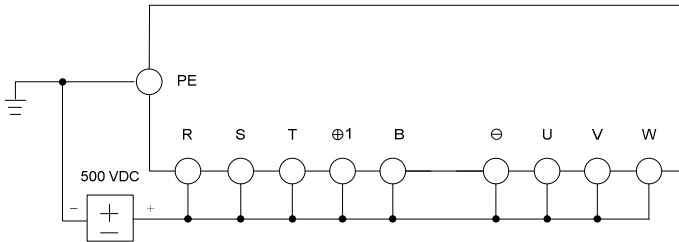

Fig:8-1 Main Circuit Insulation Test for SY8600-0R4G-2~SY8600-2R2G-2、SY8600-0R7G/1R5P-4~SY8600-015G/018P-4

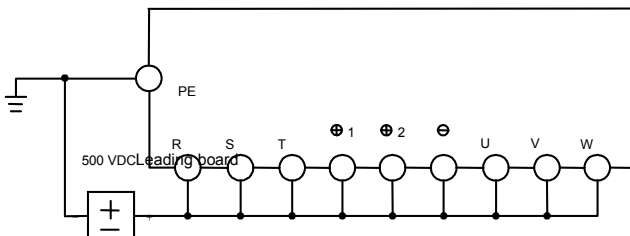

Fig:8-2 Main Circuit Insulation Test for SY8600-018G/022P-4~SY8600-400G-4

- ◆ Megameter voltage can only be imposed between the public conducting wire of the main circuit and the PE terminal;

- ◆ The normal indication value of the megameter is 200MΩ or above.

Appendix A Communication Protocol

1. Application range

Universal Variable Speed Drive connects with PLC or host computer via RS485 bus, which adopts single master and multi-slave network structure.

2. Physical description

Interface: RS485 Bus, asynchronous, half-duplex

Each segment on the network bus can have up to 32 stations.

2.1. Data format

- 0: 8, N, 2 for RTU (MODBUS) (Default)
- 1: 8, E, 1 for RTU (MODBUS)
- 2: 8, 0, 1 for RTU (MODBUS)
- 3: 7, N, 2 for ASCII (MODBUS)
- 4: 7, E, 1 for ASCII (MODBUS)
- 5: 7, 0, 1 for ASCII (MODBUS)
- 6: 8, N, 1 free communication format
- 7: 8, E, 1 free communication format
- 8: 8, 0, 1 free communication format

2.2. Baud rate

Available baud rate: 1200, 2400, 4800, 9600, 19200, 38400, 115200

The default value is 9600 BPS.

2.3. Communication address

Slave address range: 1~32

2.4. Communication mode

The drive works as slave, and PLC or host computer works as master. Communication of master is polling, and the slave is in response mode.

2.5 Main function



a. Operation control:

Run, Stop, Jog start, Jog stop, free run to stop, Dec to Stop, fault reset, etc.

b. Operation monitor:

Running frequency, frequency setting, output voltage, output current, close loop feedback, close loop reference, etc.

c. Operation of function code:

Read and write value of function code, which includes:

Present running frequency, present frequency setting, output voltage, current, close loop feedback, close loop reference, etc.

3. Free communication Protocol

3. 1 Data:

Character format: 8, N, 1, 8 bit data, one bit stop, no parity

8, E, 1, 8 bit data, one bit stop, Even parity

8, O, 1, 8 bit data, one bit stop, Odd parity

1. A message from computer to inverter

BYTE0	BYTE1	BYTE2	BYTE3	BYTE4	BYTE5	BYTE6	BYTE7	BYTE8	BYTE9	BYTE10
HD	AD	CD	OP		DT		CON		ED	SUM

Item	Byte Name	Detail
HD	Start byte	02H, one byte
AD	address	Inverter address, one byte, 0 is broadcast address
CD	Parameter R/W command	One byte 0h: no operation 1h: read parameter from the inverter 10h: write parameter from the inverter, not store into eeprom 11h: write parameter from the inverter, store into eeprom
OP	Parameter number	Parameter number, two bytes, BYTE3 is lower byte, BYTE4 is higher byte
DT	Parameter value	Parameter value, two bytes, BYTE5 is lower byte, BYTE6 is higher byte
CON	Control word	Command word, two bytes, BYTE7 is lower byte, BYTE8 is higher byte Bits of BYTE7 are defined as following: bit0 =1, run command =0, no command



		bit1 =1, forward =0, reverse bit2 =1, forward jog start =0, forward jog stop bit3 =1, reverse jog start =0, reverse jog stop bit4 0-» 1, Fault reset command bit5 reserved bit6 =1, free stop command =0, no command bit7 =1, decrease stop command =0, no command BYTE8 reserved
ED	End byte	A0H, one byte
SUM	Xor check	Xor form BYTE1 to BYTE9

2. A message from the inverter to the computer

BYTE0	BYTE1	BYTE2	BYTE3	BYTE4	BYTE5	BYTE6	BYTE7	BYTE8	BYTE9	BYTE10
HD	AD	CT	OP		DT		ST		ED	SUM

Item	Byte name	Detail
HD	Start byte	02H, one byte
IN	address	Inverter address, one byte, 0 is broadcast address
CT	Parameter operation status	One bye 0: success 1: data received is exceed the range 2: address is exceed the range 3: data can not be modified while inverter is running 4: data is read only, can not be modified
OP	Parameter number	Parameter number, two bytes, BYTE3 is lower byte, BYTE4 is higher byte
DT	Parameter value	Parameter value, two bytes, BYTE5 is lower byte, BYTE6 is higher byte
ST	Status word	Status word of the inverter, two bytes, BYTE7 is lower byte, BYTE8 is higher byte. Bits of BYTE7 are defined as following: bit0 =1, forward run

		=0, reserve run bit1 =1, inverter fault =0, inverter no fault bit2 =1, inverter running =0, inverter stop bit3 =1, data valid =0, data invalid bit4 =1, RS485 frequency setting =0, load frequency setting BYTE8 is the error code
ED	End byte	A0H, one byte
SUM	Xor check	Xor form BYTE1 to BYTE9

3. 2 Application note

1. The OP,DT,ST,CON in communication protocol are two bytes. The address calculation of OP is converting the parameter address of the parameter list to HEX value. For example, 270 parameter, convert to 10E in hex format; the lower byte of OP is 0eh;the higher byte of OP is 01h. Other parameters that are not listed in parameter table are as following table.

1000H	Status word	1001H	Errorcode	1002 H	Control word
1003H	Frequency setting	1004H	Running frequency	1005H	Output current
1006H	Output voltage	1007H	DC bus voltage	1008H	Overload rate
1009H	Preset line speed	100AH	Running line speed	100BH	Output torque
100CH	PI reference	100DH	PI feedback	100EH	reserved
100FH	Analog input AI1	1010H	Analog input AI2	1011H	I/O status
1012H	External counting value	1013H	PID Set		

2. For example, the computer set the set frequency of the inverter to 50.00Hz and send the run command to the inverter. The address of the inverter is 01h. The OP of the setting frequency is 1003h in hex format. The Setting frequency 50.00(5000) is converted to 1388h in hex format.

A message from computer to the inverter:

02H	01H	10H	03H	10H	88H	13H	03H	00H	A0H	3AH
-----	-----	-----	-----	-----	-----	-----	-----	-----	-----	-----

The inverter response:

02H	01H	00H	03H	10H	88H	13H	1DH	00H	A0H	34H
-----	-----	-----	-----	-----	-----	-----	-----	-----	-----	-----

3. 3 Fault and troubleshooting

1. The protocol provide Start byte, end byte , xor check means to assure the correctness of the communication.
2. There must be two bytes interval between two meassage.

3. After the host issue a message, if the inverter does not response in seven bytes interval, the over time fault of communication takes place.

4. MODBUS Protocol

4.1 Character format

1. ASCII

Communication adopts hexadecimal system, and the valid ASCII characters are: “0” ... “9”, “A”... “F”, which is expressed in hexadecimal format. Such as:

ASCII character: ‘0’ ‘1’ ‘2’ ‘3’ ‘4’ ‘5’ ‘6’ ‘7’ ‘8’
 ‘9’ ‘A’ ‘B’ ‘C’ ‘D’ ‘E’ ‘F’

ASCII code (Hex):30H 31H 32H 33H 34H 35H 36H 37H 38H 39H 41H
 42H 43H 44H 45H 46H

7,N,2

start	0	1	2	3	4	5	6	stop	stop
-------	---	---	---	---	---	---	---	------	------

7,E,1

start	0	1	2	3	4	5	6	even	stop
-------	---	---	---	---	---	---	---	------	------

7,O,1

start	0	1	2	3	4	5	6	odd	stop
-------	---	---	---	---	---	---	---	-----	------

2. RTU

8,N,2

start	0	1	2	3	4	5	6	7	stop	stop
-------	---	---	---	---	---	---	---	---	------	------

8,E,1

start	0	1	2	3	4	5	6	7	even	stop
-------	---	---	---	---	---	---	---	---	------	------

8,O,1

start	0	1	2	3	4	5	6	7	odd	stop
-------	---	---	---	---	---	---	---	---	-----	------



4.2 Function code

Function code	Description
03H	Read data
06H	Modify data
08H	Loop detection

2. Function code description

RTU

(1) Read data

Frame head and frame tail are used to ensure input time (without any information) larger than 10ms. Each time, reading data should be less than 30 bytes.

Message format of master request:

Slave address	Function code	Start address of data		Data quantity (Unit: word)		Redundancy check	
		MSB	LSB	MSB	LSB	LSB	MSB
1 byte	03H					B	

Message format of slave response:

Slave address	Function code	Data quantity	Data 1		...	Data n		Redundancy check	
1 byte	03H	1 byte	MSB	LSB	...	MSB	LSB	LSB	MSB

MSB: high byte of double byte number; LSB: low byte of double byte number.

(2) Modify data

Message format of master request:

Slave address	Function code	Start address of data		Modified value		Redundancy check	
1 byte	06H	MSB	LSB	MS	LSB	LSB	MSB

				B			
--	--	--	--	---	--	--	--

Message format of slave response:

Slave address	Function code	Start address of data		Modified value		Redundancy check	
1 byte	06H	MSB	LSB	MS B	LSB	LSB	MSB

(3) Loop detection

The command is used to test whether communication between main control equipment (usually PC or PLC) and the drive is normal. After receiving data content, the drive will return it to main control equipment without any modifying.

ASCII:

(1) Read data:

Reading data should be less than 30 bytes at a time.

Message format of master request:

Frame head	Slave address		Function code		Data address				Data quantity				LRC		Frame tail	
	MS B	LS B	'0' ,	'3' ,	4	3	2	1	4	3	2	1	MS B	LS B	C R	L F
‘.’																

Message format of slave response:

Frame head	Slave address		Function code		Data address				Data quantity				LRC		Frame tail	
	MS B	LS B	'0' ,	'3' ,	4	3	2	1	4	3	2	1	MS B	LS B	C R	L F
‘.’																

(2) Modify data:



Message format of master request:

Frame head	Slave address		Function code		Data address				Modified value				LRC		Frame tail	
	MS B	LS B	'0'	'6'	4	3	2	1	4	3	2	1	MS B	LS B	C R	L F
‘.’																

Message format of slave response:

Frame head	Slave address		Function code		Data address				Modified value				LRC		Frame tail	
	MS B	LS B	'0'	'6'	4	3	2	1	4	3	2	1	MS B	LS B	C R	L F
‘.’																

3. Examples

(1) Function code 03H: Read parameter data

ASCII mode:

Format of query message:

Starting character	‘.’
Slave address	‘0’
	‘1’
Function code	‘0’
	‘3’
Data address	‘0’
	‘2’
	‘0’
	‘0’
Data quantity	‘0’

Format of response message:

Starting character	‘.’
Slave address	‘0’
	‘1’
Function code	‘0’
	‘3’
Data address	‘0’
	‘0’
	‘0’
	‘2’
Data content	‘1’

(word)	'0'			'5'
	'0'			'5'
	'1'			'9'
LRC	'F'		LRC	'8'
	'9'			'C'
END	CR		END	CR
	LF			LF

RTU mode:

Format of query message:

Slave address	01H
Function code	03H
Data address	02H
	00H
Data quantity (Word)	00H
	01H
Low byte CRC	85H
High byte CRC	B2H

Format of response message:

Slave address	01H
Function code	03H
Data address	00H
	02H
Data content	15H
	59H
Low byte CRC	2AH
High byte CRC	A0H

(2) Function code 06H: Write parameter data

ASCII mode:

Format of query message:

Starting character	'.'
Slave address	'0'
	'1'
Function code	'0'
	'6'
Data address	'0'

Format of response message:

Starting character	'.'
Slave address	'0'
	'1'
Function code	'0'
	'6'
Data address	'0'

	'1'			'1'
	'0'			'0'
	'0'			'0'
Modified value	'1'		Modified value	'1'
	'7'			'7'
	'7'			'7'
	'0'			'0'
LRC	'7'		LRC	'7'
	'1'			'1'
END	CR		END	CR
	LF			LF

RTU mode:

Format of query message:

Slave address	01H
Function code	06H
Data address	01H
	00H
Modified value	17H
	70H
Low byte CRC	86H
High byte CRC	22H

Format of response message:

Slave address	01H
Function code	06H
Data address	01H
	00H
Modified value	17H
	70H
Low byte CRC	86H
High byte CRC	22H

(3) Function code 08H: loop detection

ASCII mode:

Format of query message:

Starting character	“.”
Slave address	‘0’

Format of response message:

Starting character	“.”
Slave address	‘0’

	'1'			'1'
Function code	'0'			Function code
	'8'			'0'
Sub-function code	'0'			Sub-function code
	'0'			'0'
	'0'			'0'
	'0'			'0'
Data content	'1'			Data content
	'2'			'1'
	'A'			'2'
	'B'			'A'
LRC	'3'			LRC
	'A'			'3'
END	CR			END
	LF			CR
				LF

RTU mode:

Format of query message:

Slave address	01H
Function code	08H
Sub-function code	00H
	00H
Data content	12H
	ABH
Low byte CRC	ADH
High byte CRC	14H

Format of response message:

Slave address	01H
Function code	08H
Sub-function code	00H
	00H
Data content	12H
	ABH
Low byte CRC	ADH
High byte CRC	14H

4.4 Control word and status word

1. Information of status word (2 bytes)(2000H)

10	=1, FWD
----	---------

	=0, REV
Bit1	=1, Drive failure
	=0, No drive failure
Bit2	=1, Running state
	=0, Stopping state
Bit3	=1, Modifying parameter valid
	=0, Modifying parameter invalid
Bit4	=1, Frequency setting via RS485
	=0, Local frequency setting
Bit5	=1, RS485 running control
	=0, Local running control

2. Information of status word (2 bytes) (2002H)

Bit0	=1, Running command
	=0, No running command
Bit1	=1, FWD
	=0, REV
Bit2	=1, Jog FWD
	=0, Jog FWD and stop
Bit3	=1, Jog REV
	=0, Jog REV and stop
Bit4	=1, Fault reset command
	=0, No fault reset command
Bit5	=1, Host computer control valid
	=0, Host computer control invalid
Bit6	=1, Free run to stop
	=0, No free run to stop
Bit7	=1, Dec to stop command
	=0, No Dec to stop command
Bit8	=1, Output enabled

	=0, Output disabled
Bit9—bit15	Reserved

3. Parameter address

Address	Name	Address	Name	Address	Name
1000H	Status word	1001H	Errorcode	1002 H	Control word
1003H	Frequency setting	1004H	Running frequency	1005H	Output current
1006H	Output voltage	1007H	DC bus voltage	1008H	Overload rate
1009H	Preset line speed	100AH	Running line speed	100BH	Output torque
100CH	PI reference	100DH	PI feedback	100EH	reserved
100FH	Analog input A11	1010H	Analog input AI2	1011H	I/O status
1012H	External counting value	1013H	PID闭环设定值		

4.5 Fault and troubleshooting

If communication fault occurs, the drive will response fault code, and report function code or 80H to the main control equipment.

For example:

ASCII mode:

Starting character	‘.’
Slave address	‘0’
	‘1’
Function code	‘8’
	‘6’
Fault code	‘0’
	‘2’
LRC	‘7’
	‘7’
End character	CR

RTU mode:

Slave address	01H
Function code	86H
Fault code	02H
Low byte CRC	C3H
High byte CRC	A1H

	LF
--	----

Fault code:

- 01 Function code error:
Function code is invalid. In the protocol, valid function codes are: 03H, 06H or 08H.
- 02 Invalid data address:
Data address is invalid
- 03 Invalid data setting
Data value is invalid.
- 04 Invalid command:
In current state, the drive can not execute this command.
- 09 Wrong CRC check
- 11 Reserved
- 12 Message characters of the command string is too short
- 13 Command string is too long, and reading string should be less than 72 characters.
- 14 Contains non-ASCII character, non-starting character or non-CR, LF end character.

Additional information

1. Function code conversion

If preset data is n, then sending data $n = n \times (1/\text{increment})$ (Refer to function parameters table)

Convert data “n” into HEX number, which is 2 bytes.

2. ASCII mode LRC check

In the example above, LRC check: $01H+03H+02H+00H+00H+01H=07H$, and it's complement= $F9H$.

RTU mode CRC check

LRC check is executed from slave address to data end character, and the operation rule is shown as following:

- Step 1: Load a 16-bit register with FFFFH. Call this the CRC register;
- Step 2: Execute XOR operation with the first message command and the lower byte of 16-bit CRC register, and put the result in the CRC register;
- Step 3: Shift the CRC register one bit to the right (toward the LSB), and fill the MSB with 0;
- Step 4: If the shifted bit is 0, save the new value of step 3 to CRC register; otherwise, execute XOR operation with A001H and CRC register, and save the result in CRC register;
- Step 5: Repeat step3~4 until 8 shifts have been performed.
- Step 6: Repeat step2~5 for the next 8-bit message command. Continue doing this until all messages have been processed. The final content of CRC register is the CRC value.

Note:

When the 16-bit CRC is transmitted in the message, the low-order byte will be transmitted first, followed by the high-order byte.

Appendix B Control Mode Setting Process

- ◆ A inverter connected to a computer

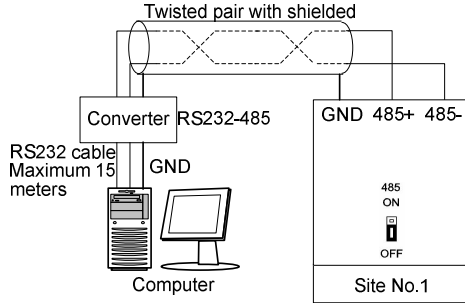

Appendix Fig.1 A inverter connected to a computer

- ◆ Several inverters connected to a computer

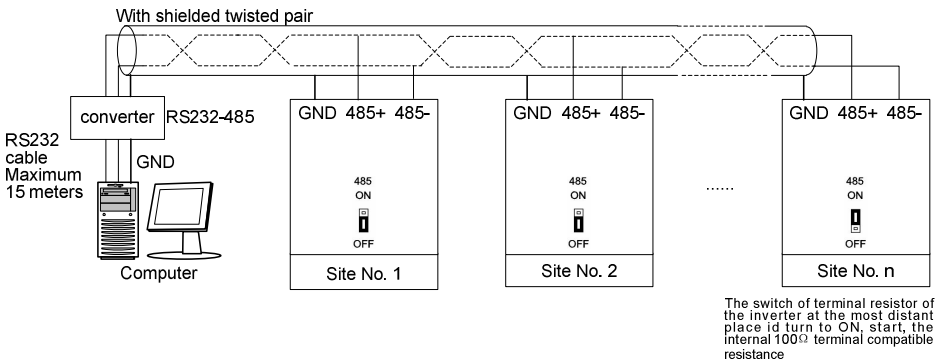

Appendix Fig.2 Several inverters connected to a computer